

Computational Structural Mechanics and Dynamics

Practice 3

Anil Bettadahalli Channakeshava,Rupalee Deepak Baldota,Arnab Samaddar Chaudhuri

21/04/2016

1 Introduction:

In this assignment we are analysing structural behaviour of different types of thick and thin plates using different types of elements and comparing the structural behavior of the plates using different types of theories of thin and thick plates.

Exercise 1: Clamped plate with a uniform load:

We have analyzed the state of stress of the quadratic plate in the figure 1 which is shown below, whose four sides are clamped and subjected to uniform load of $q=1.0e4 \text{ N/m}^2$ using different types of elements like triangular plate elements DKT,triangular Reissner-Midlin elements with 6 nodes with reduced integration and quadrilateral elements CLLL using the given concrete material properties like $E=3.0e10 \text{ N/m}^2, \nu = 0.2$ and $t=0.1 \text{ m}$.And also obtained the deflection/displacement in the center of the plate and compared with the analytical solution.

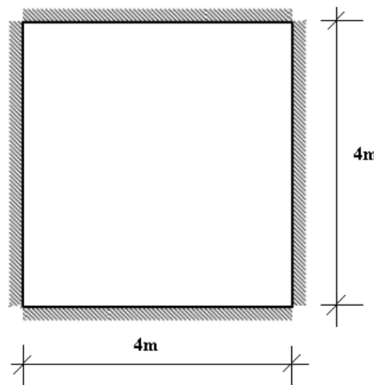

Figure 1: Clamped square plate subjected to uniform load

Using DKT elements:

The following figures shows simulated images of stresses due to Bending moment,Shear and Rotations along X and Y using mesh element size of 0.3.

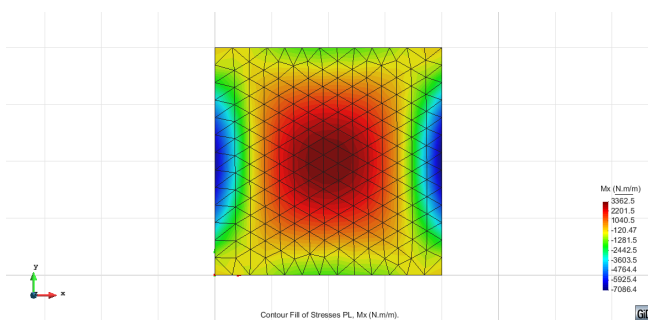

Figure 2: Bending Moment along X

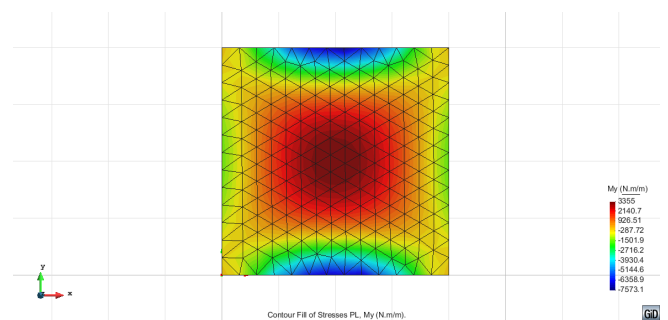

Figure 3: Bending Moment along Y

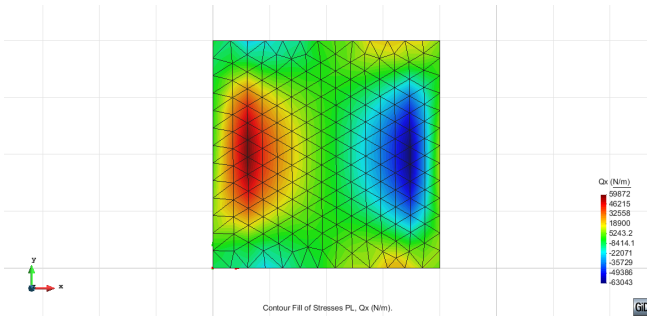

Figure 4: Shear along X

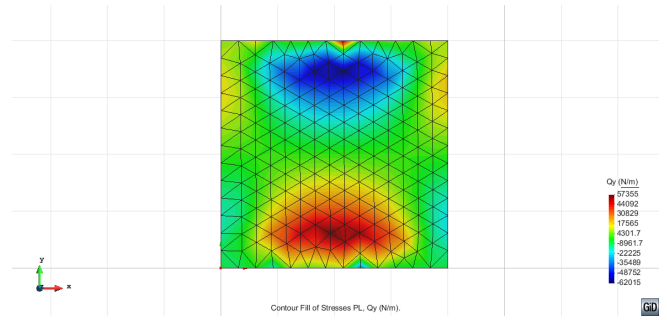

Figure 5: Shear along Y

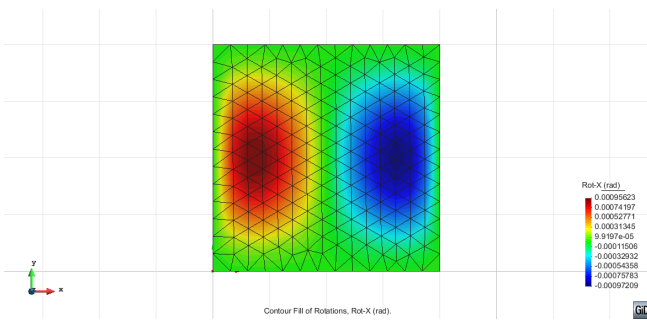

Figure 6: Rotation along X

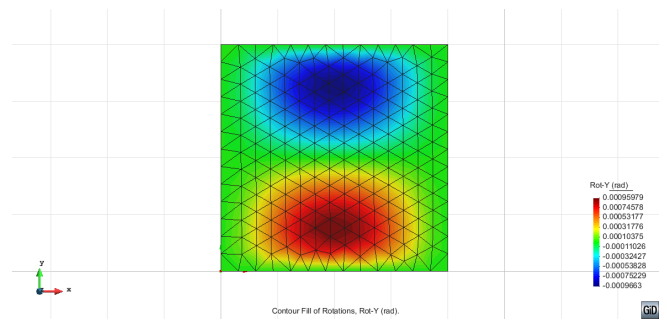

Figure 7: Rotation along Y

Using Reissner-Midlin elements with 6 nodes with reduced integration:

The following figures show simulated images of stresses due to Bending moment, Shear and Rotations along X and Y using mesh element size of 0.3.

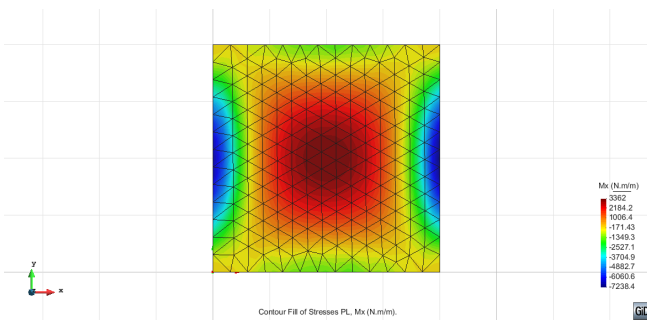

Figure 8: Bending Moment along X

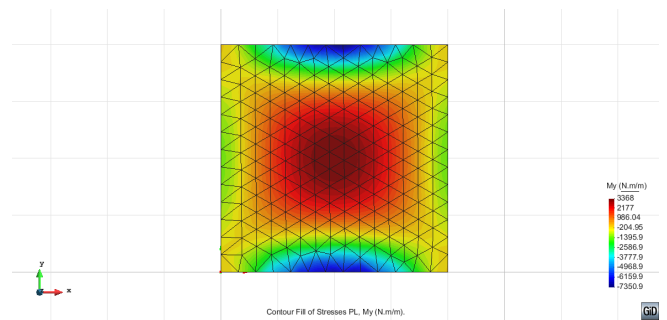

Figure 9: Bending Moment along Y

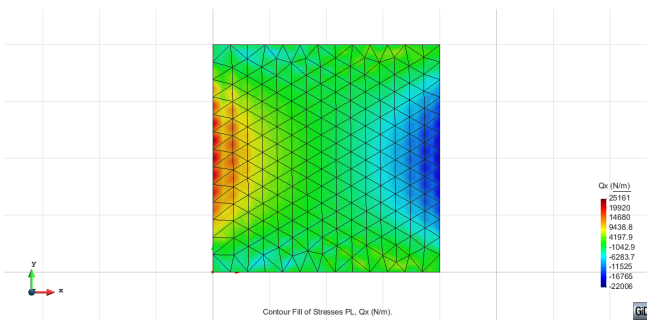

Figure 10: Shear along X

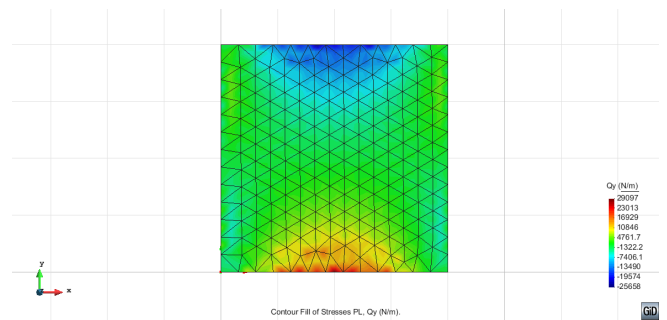

Figure 11: Shear along Y

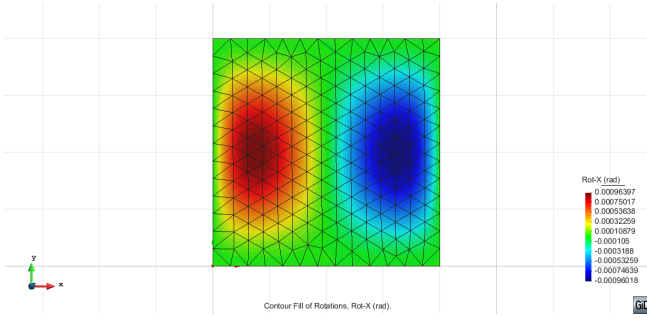

Figure 12: Rotation along X

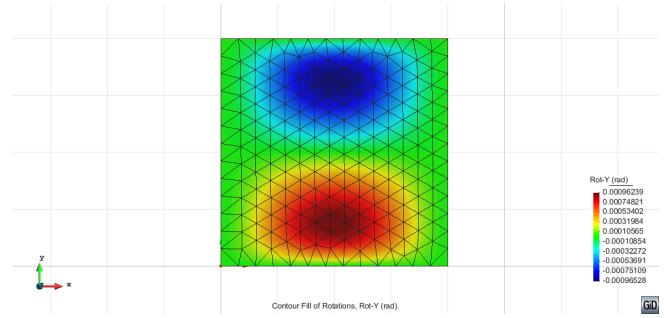

Figure 13: Rotation along Y

Using quadrilateral elements CLLL:

The following figures shows simulated images of stresses due to Bending moment, Shear and Rotations along X and Y using mesh element size of 0.3.

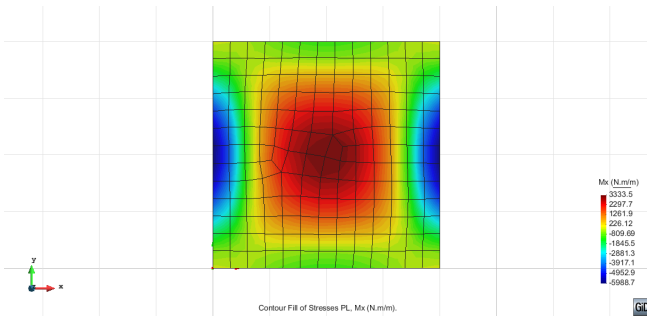

Figure 14: Bending Moment along X

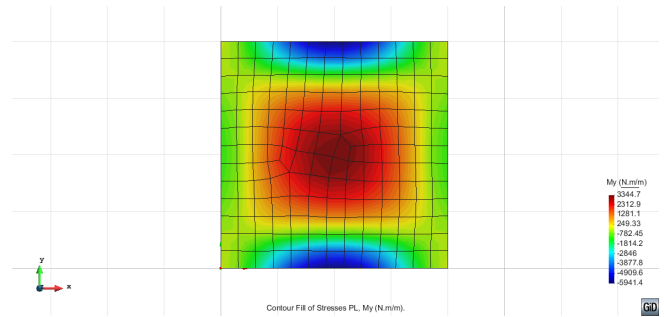

Figure 15: Bending Moment along Y

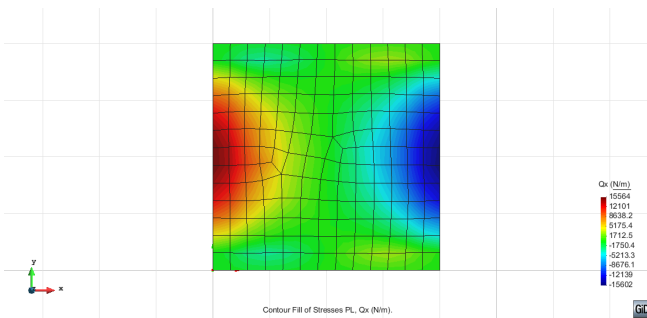

Figure 16: Shear along X

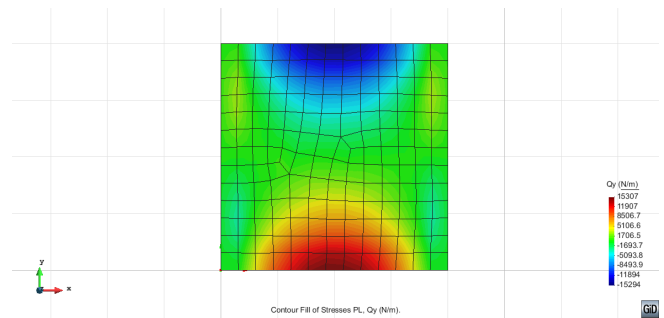

Figure 17: Shear along Y

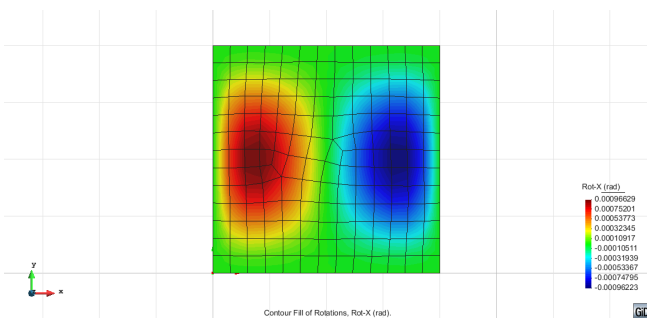

Figure 18: Rotation along X

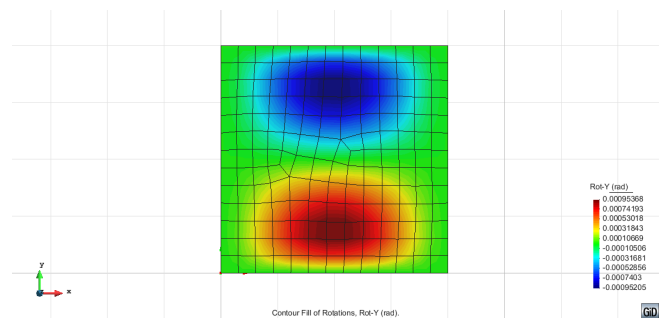

Figure 19: Rotation along Y

Comments: From the above figures of Bending moment, the analysis is in line with our assumptions that there will be maximum bending moment at the center of the plate, decreasing gradually in the outward directions since the plate is clamped along 4 edges. Therefore maximum stress occurs at the center of the plate. From the figures of shear, we observe that shearing action takes place near the clamped edges only, which leads to maximum shear stress at the edges. Therefore it is advisable to reinforce the material along the edges to avoid crack propagation.

Central deflection:

Analytical Solution:

Analytical solution of central deflection for clamped plate is calculated by using the formula:

$$Z_{act} = \frac{\alpha q L^4}{D} \quad m$$

$$D = \frac{Et^3}{12(1 - \nu^2)}$$

Where,

$$\alpha = 0.00126, E = 3.0e10N/m^2, \nu = 0.2, t = 0.1m, L = 4m, q = 1.0e4N/m^2$$

Therefore,

$$D = \frac{(3.0e10)(0.1^3)}{12(1 - 0.2^2)} = 2.60416 \times 10^6 \quad Nm$$

Central deflection,

$$Z_{act} = \frac{(0.00126)(1.0e4)(4^4)}{2.60416 \times 10^6} = 1.2386 \times 10^{-3}m$$

Numerical Solution:

Numerical solution for central deflection (Z) of clamped plate using given conditions for different elements is as shown in below figures.

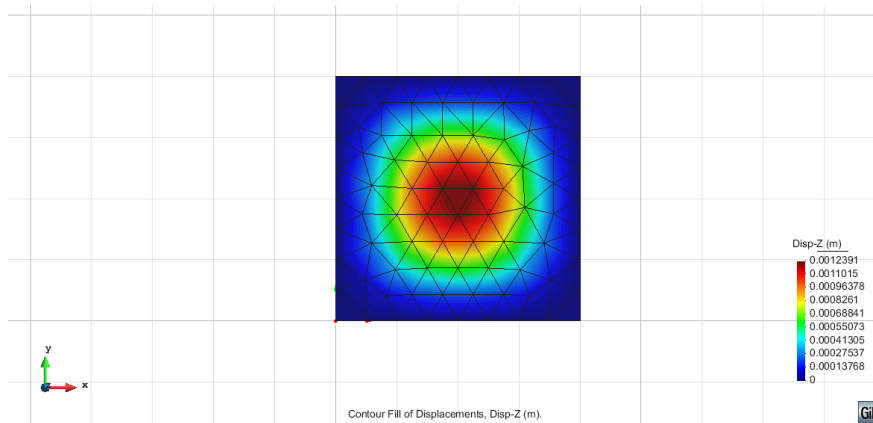

Figure 20: triangular DKT elements

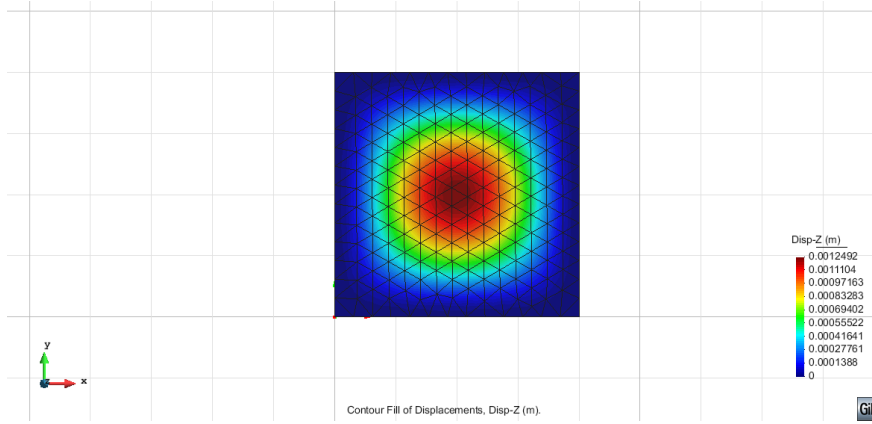

Figure 21: Reissner-Midlin elements(6 nodes with reduced integration)

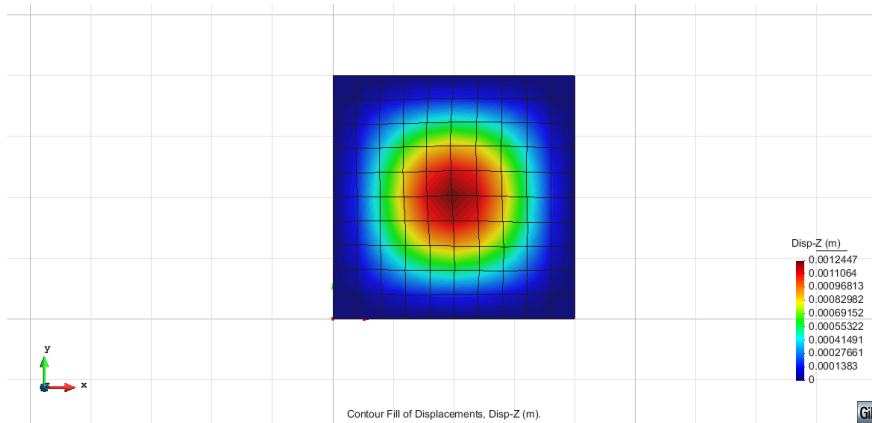

Figure 22: quadrilateral elements CLLL

Below figure shows the convergence plot of central deflection v/s number of nodes for different elements like triangular plate elements DKT, triangular Reissner-Midlin elements with 6 nodes with reduced integration and quadrilateral elements CLLL which was used for analysis.

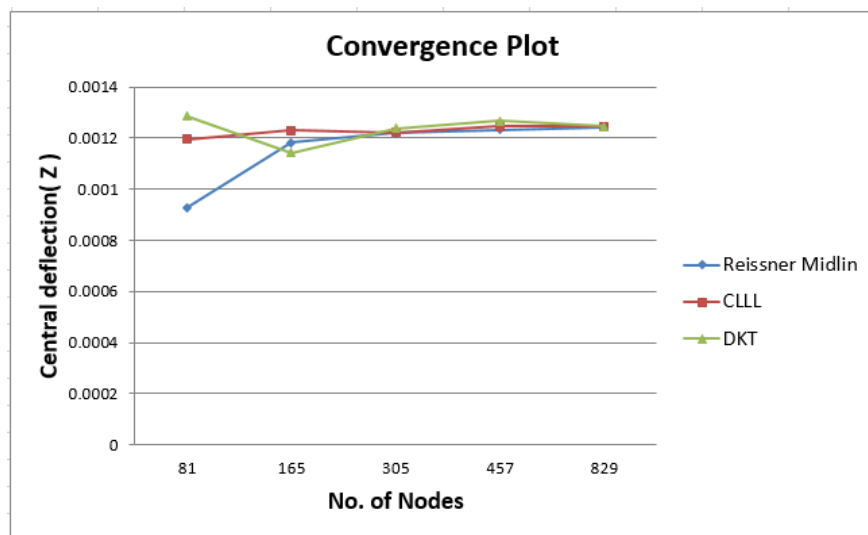

Figure 23: Convergence plot of central deflection(max.Z) v/s no. of nodes

Comments: As we can see from above plot that for numerical solution of central deflection, the quadrilateral elements CLLL and DKT triangular elements converge very fast towards analytical solution than Reissner-Midlin elements with 6 nodes. From theoretical knowledge we know that quadrilateral elements CLLL and DKT triangular elements gives a good approximation and accuracy and now it is proved from our analysis. Reissner Midlin elements

shows large variation from analytical solution initially, but after refining mesh it converges gradually. To conclude we can say that DKT triangular elements and quadrilateral elements CLLL can be recommended for thin plate analysis.

Exercise 2: Thin plate with internal hole:

We have analyzed the structural behavior of the given thin steel plate subjected to to uniform load of $q=1.0e4 \text{ N/m}^2$ as shown in figure below using the theory of thin plates with triangular elements DKT, applying the given material properties of steel: $E=2.1e11 \text{ N/m}^2, \nu = 0.3, t=0.05 \text{ m}$ and $\gamma = 7.80e4 \text{ N/m}^3$. The results obtained are explained below with plots.

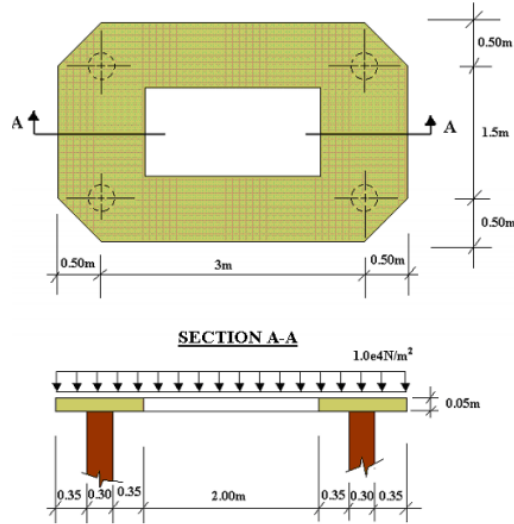

Figure 24: Thin plate with internal hole subjected to uniform load

Bending Moments:

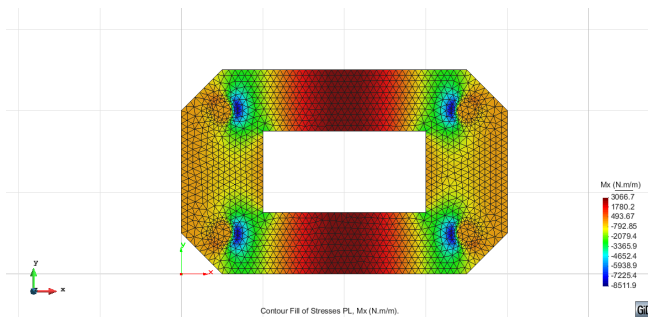

Figure 25: Bending Moment along X

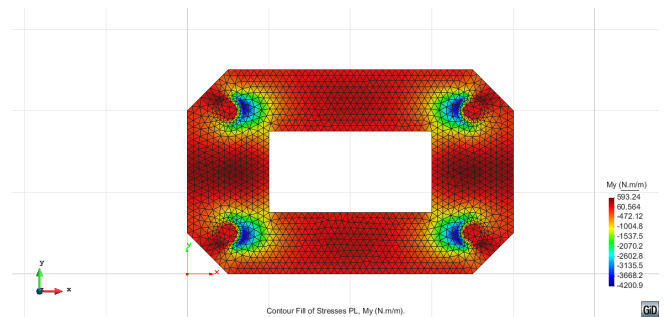

Figure 26: Bending Moment along Y

Shear:

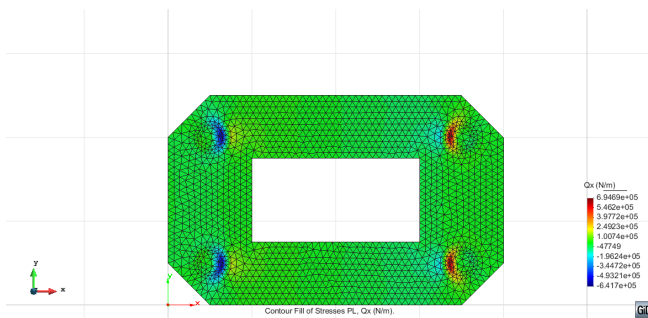

Figure 27: Shear along X

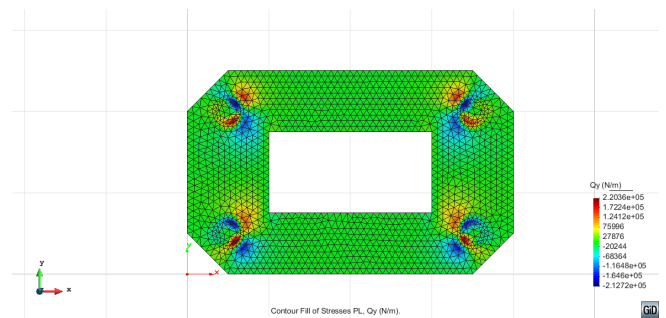

Figure 28: Shear along Y

Rotations:

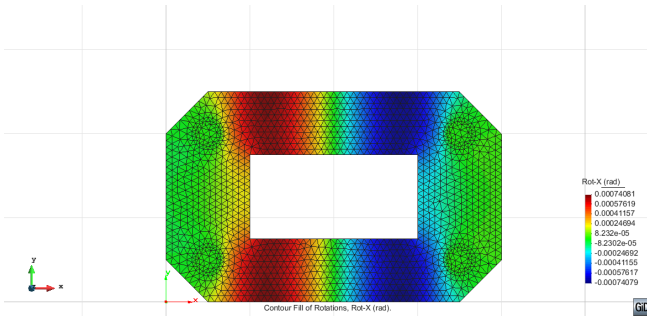

Figure 29: Rotation along X

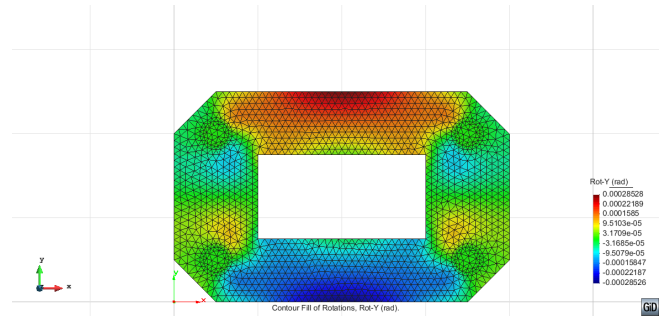

Figure 30: Rotation along Y

Comments: From the above figures of bending moment along X, it can be observed that stresses due to bending moment are maximum at the mid section and decrease gradually towards outer edges since they are supported by columns and hence the failure can occur at the mid section. And also we can see from figures of shear, that stresses due to shear are maximum around the 4 corner surfaces intersecting with the columns which may lead to cracks.

Deflection/displacement along Z:

The below figure shows the deflection (Z) of given thin plate with internal hole subjected to uniform load of 'q' using triangular DKT elements with refined mesh of size (0.08). As we can see from below figure, the maximum deflection is at the longer edges along the internal hole which is not supported by any columns. The positions (4 corners of plate) where plate is supported by 4 columns has least deflection as it is constrained. The maximum deflection (Z) obtained after analysis with refined mesh is, $Z(\max) = 0.0007316$ m. And also the convergence plot is shown in figure 32 below.

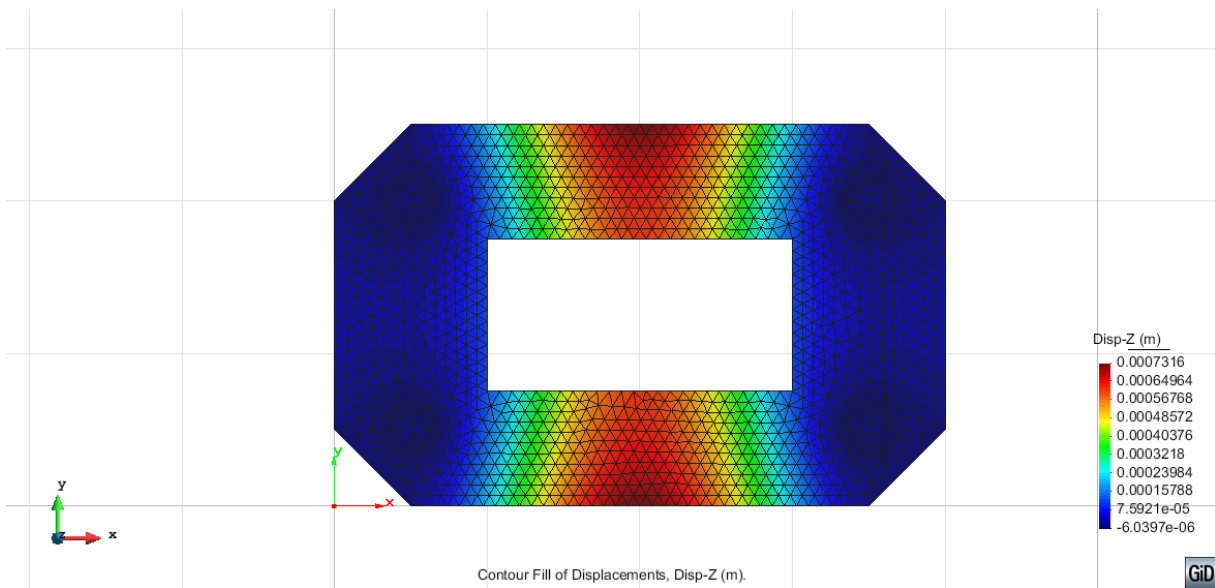

Figure 31: Deflection of plate under uniform load 'q'

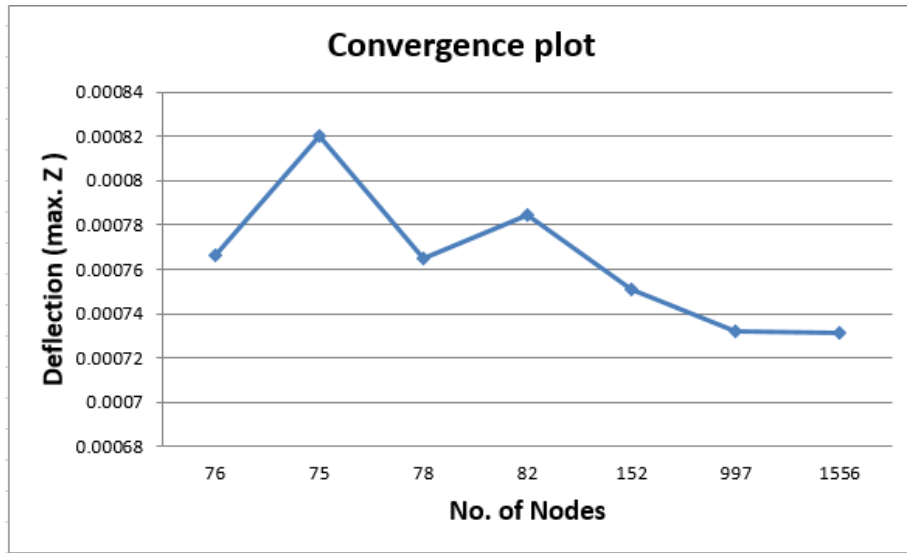

Figure 32: Convergence plot of central deflection (max.Z) v/s no. of nodes

As we can see from the above convergence plot of deflection(max.Z) v/s no. of nodes, we can say that by using triangular DKT elements, the solution initially has variation and hence as we refine mesh more, it is converging fast (from node number 900). And hence we can conclude that as this element works better for thin plates with internal hole.

Exercise 3: Thick circular plate with internal hole:

We have analyzed the structural behavior of the given thick circular reinforced concrete plate supported on four columns, subjected to its dead weight and uniform load of $q=1.0e4 \text{ N/m}^2$ as shown in figure below using the theory of thick plates of Reissner-Mindlin, applying the given material properties of steel: $E=3.0e10 \text{ N/m}^2, \nu = 0.2, t=0.25 \text{ m}$ and $\gamma = 2.4e4 \text{ N/m}^3$. The results obtained are explained below with plots.

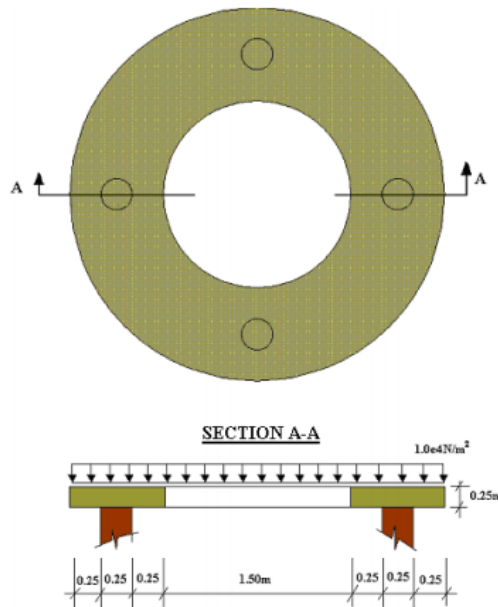

Figure 33: Thick circular plate with internal hole subjected to uniform load

Bending Moments:

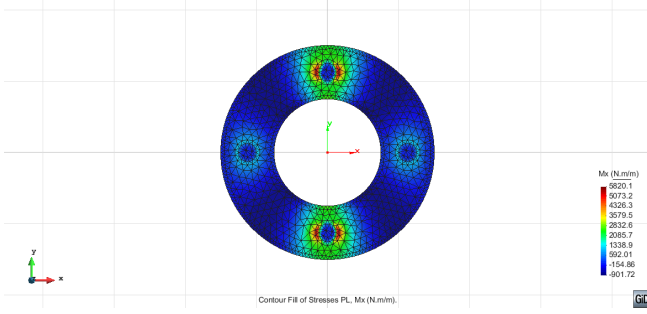

Figure 34: Bending Moment along X

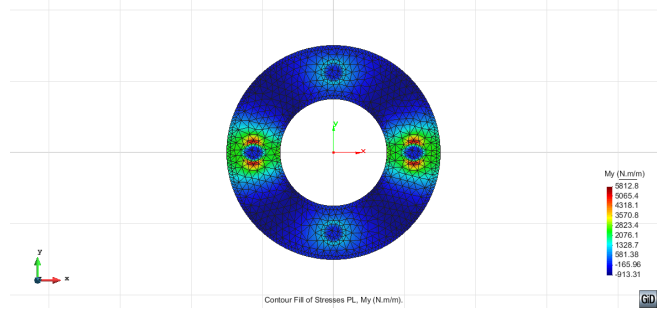

Figure 35: Bending Moment along Y

Shear:

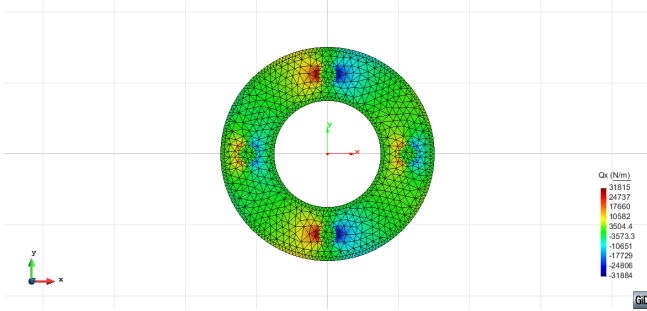

Figure 36: Shear along X

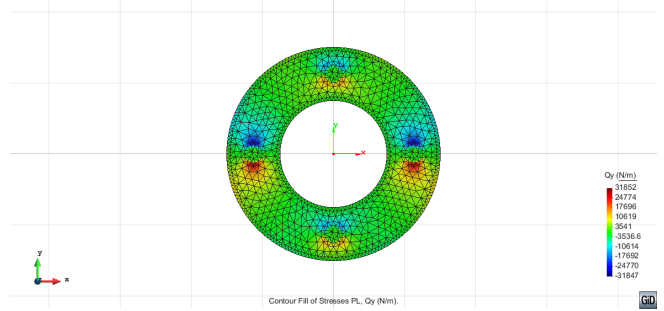

Figure 37: Shear along Y

Rotations:

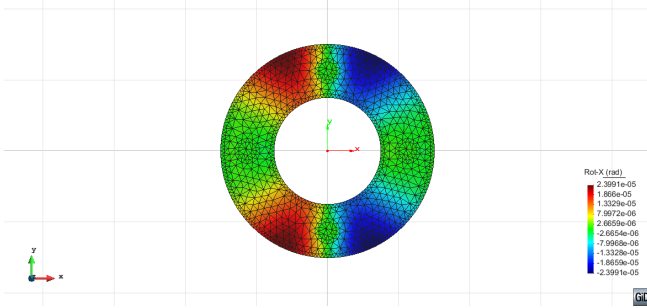

Figure 38: Rotation along X

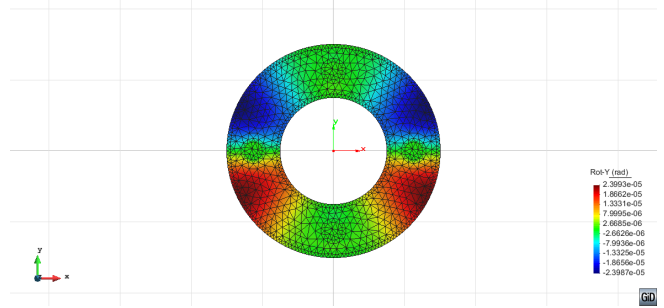

Figure 39: Rotation along Y

Comments: From the above simulated figures, it is observed that with high rotation at the constrained columns along X and Y axis, the bending moment at those positions is also high, which verifies that bending moments are directly proportional to the first derivative of rotations. Due to bending, high equal and opposite tensile forces occur near the 4 columns, which leads to maximum stresses around the 4 columns supporting the circular concrete plate. And also we can observe that shear is maximum around the 4 columns which are supporting circular plate, which may lead to cracks at those regions.

Deflection/displacement along Z:

The below figure shows the deflection (Z) of given thick circular concrete plate with internal hole subjected to its dead weight and a uniform load of 'q' using triangular elements of Reissner-Mindlin with six nodes and reduced integration and with refined mesh of size (0.1). As we can see from below figure, the maximum deflection is around the regions of circular plate which is not supported by any columns. The positions where circular plate is supported by 4 columns has least deflection as it is constrained. The maximum deflection (Z) obtained after analysis with refined mesh is, $Z(\max) = -1.9281 \times 10^{-5}$ m. And also the convergence plot is shown in figure 41 below.

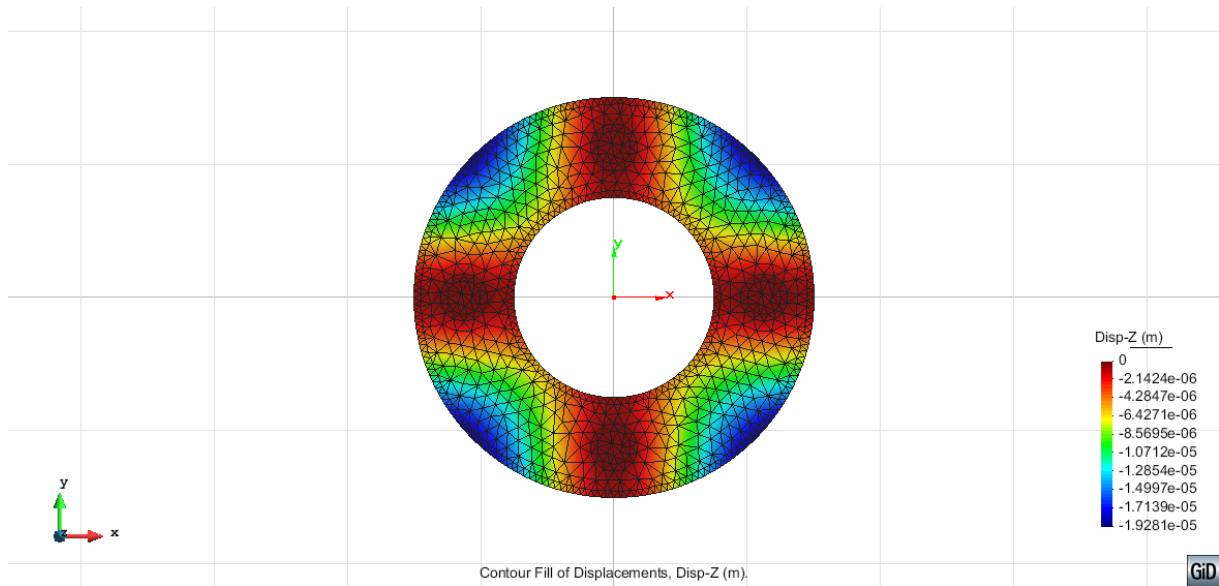

Figure 40: Deflection of circular plate under its dead weight and uniform load 'q'

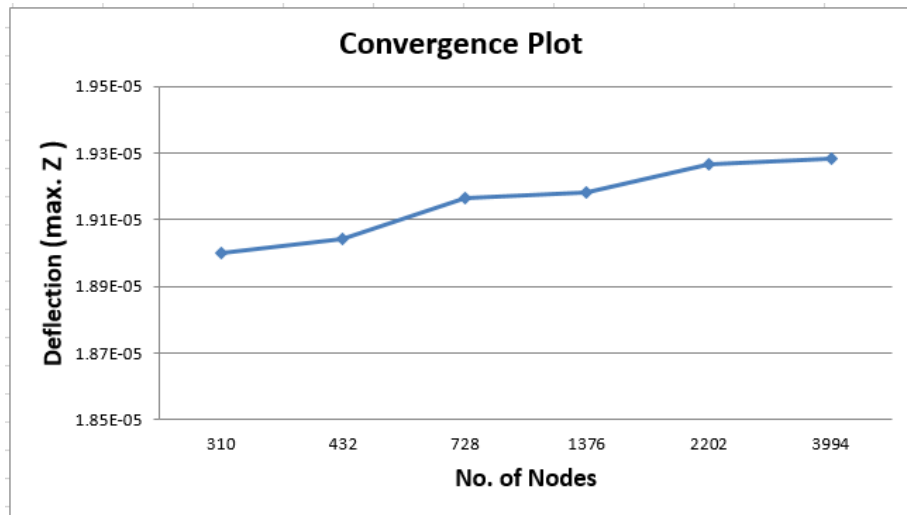

Figure 41: Convergence plot of central deflection (max.Z) v/s no. of nodes

As we can see from the above convergence plot of deflection(max.Z) v/s no. of nodes, we can say that by using triangular elements of Reissner-Mindlin with six nodes and reduced integration, the slope of the convergence plot gradually converges towards the analytical solution and as we refine mesh more, it is converging very fast (from node number 3900). And hence we can conclude that this element works better for thick plates with internal hole.