



UPC - BARCELONA TECH  
MSc COMPUTATIONAL MECHANICS  
Spring 2018

---

# Computational Structural Mechanics and Dynamics

---

**GiD HOMEWORK 4**

Prasad ADHAV

# Contents

<b>1</b>	<b>Exercise # 1: Cylindrical tank analyzed with revolutions shell elements</b>	<b>2</b>
1.1	Purpose of the example . . . . .	2
1.2	Analysis . . . . .	2
1.2.1	Preprocessing . . . . .	2
1.2.2	Processing . . . . .	7
1.2.3	Results . . . . .	8
<b>2</b>	<b>Exercise # 2: Cylindrical tank analyzed with 3D shell elements</b>	<b>14</b>
2.1	Purpose of the example . . . . .	14
2.2	Analysis . . . . .	14
2.2.1	Preprocessing . . . . .	14
2.2.2	Processing . . . . .	19
2.2.3	Results . . . . .	19

# 1 Exercise # 1: Cylindrical tank analyzed with revolutions shell elements

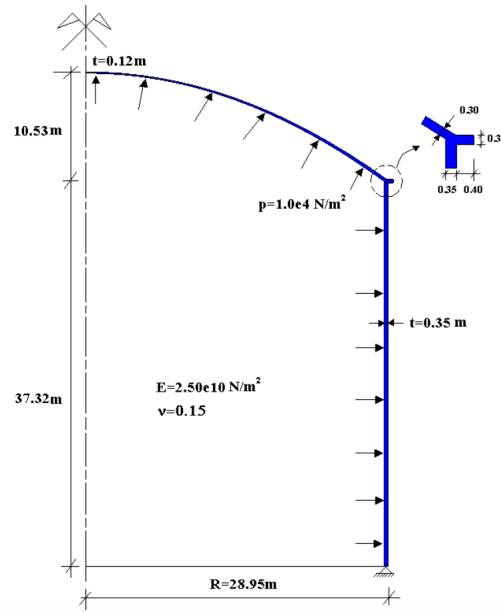

Figure 1.1: Exercise #1

## 1.1 Purpose of the example

In this first exercise we aim to analyze the state of stress of the cylindrical tank in Figure 1.1. For this purpose we will first use revolution shell elements.

## 1.2 Analysis

### 1.2.1 Preprocessing

#### Geometry

First, we define the geometry using the GiD sketcher tool.

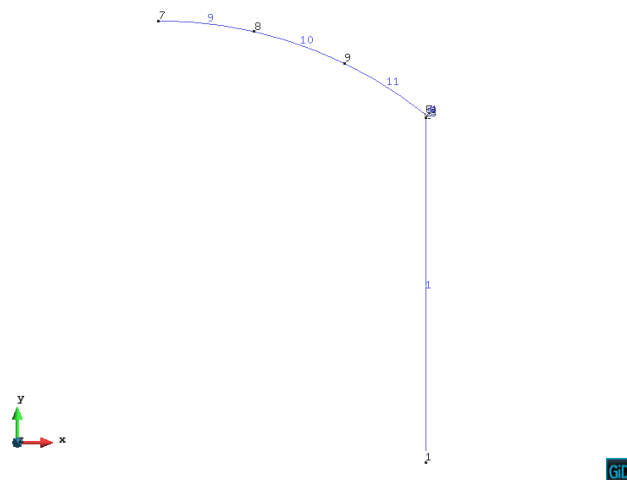

Figure 1.2: Geometry of the cylindrical tank.

It is important to note that we just need to define lines. Thickness will be provided later in the material section.

## Data

### Problem type

Once the geometry is defined, we can now choose the type of problem that must be solved using *RamSeries*. For this case, we are dealing with a revolution shell. Thus, we choose

*Data/ProblemType/Ramseries\_Educational\_2D/Rev\_Shell*

### Boundary Conditions

The type of boundary conditions that are considered in this example are the following:

- Displacement Constraints / Points-Constraints: point #1 in Figure 1.2 has its movement completely restricted and point # 7 can move in the vertical direction, in correspondence with the symmetry condition.

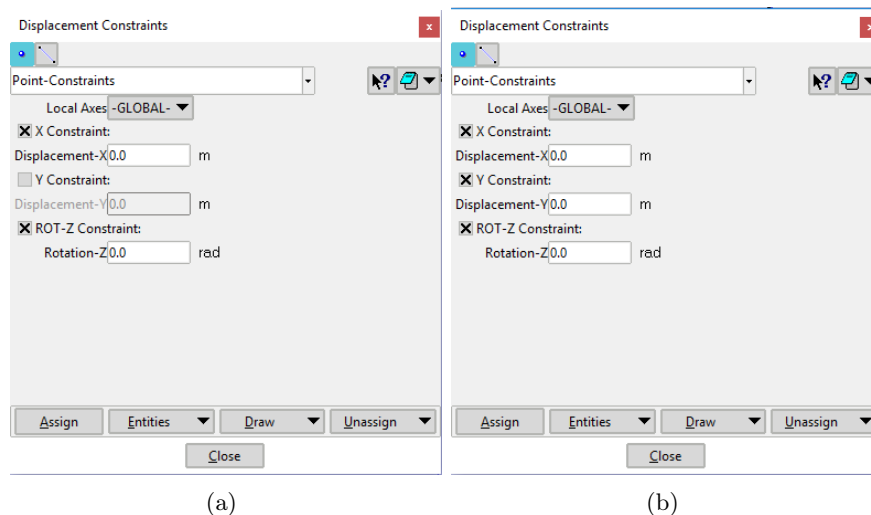
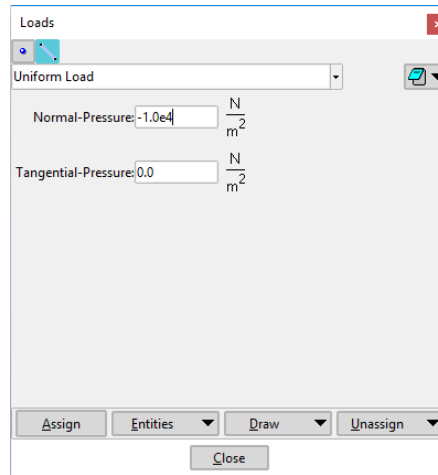
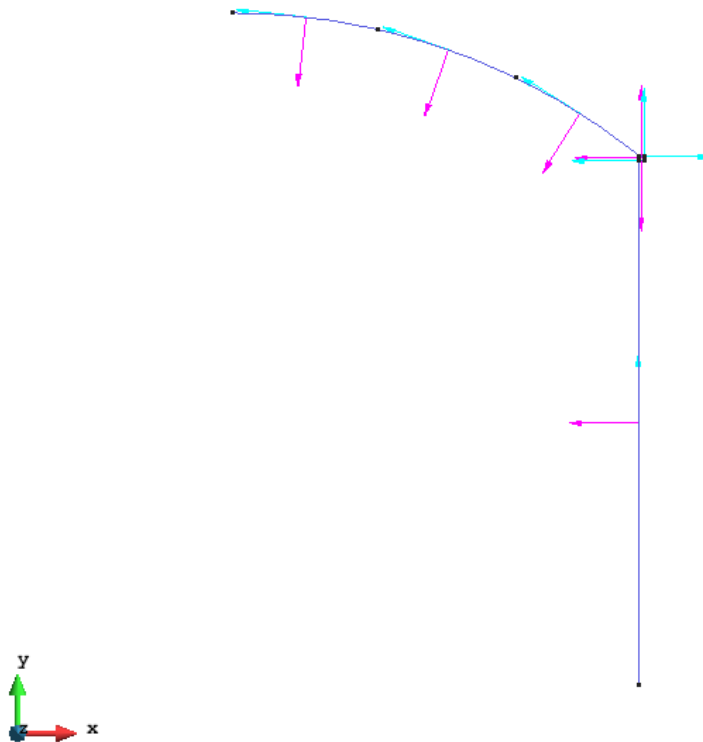

Figure 1.3: (a) Definition of symmetry condition for point # 7 and (b) displacement fixed condition for point # 1.

- Load / Uniform Load : a uniform distributed load of value  $p = 1.0e4 \text{ N/m}^2$  is considered acting uniformly on the whole shell. It is important to check the definition of the normal on the shell, so that the pressure is applied in the correct direction.



(a)



(b)

Figure 1.4: (a) Definition of the loading and (b) normal of the different surfaces. It is important to check them in order to apply the distributed pressure consistently.

## Material

The tank is made of a material with the following mechanical characteristics:

$$E = 2.50e10 \text{ N/m}^2 \quad ; \quad \nu = 0.15 \quad ; \quad \gamma = 25000 \text{ N/m}^3$$

Now we need to define different materials in order to apply the different thickness of the shells. The curved part has been divided into three parts with thickness  $t = 0.3$  (material 2),  $t = 0.21$  (material 3) and  $t = 0.12$  (material 4) respectively in order to simulate the thickness transition from one end to another. The vertical part has a constant thickness of  $t = 0.35$  (material 1).

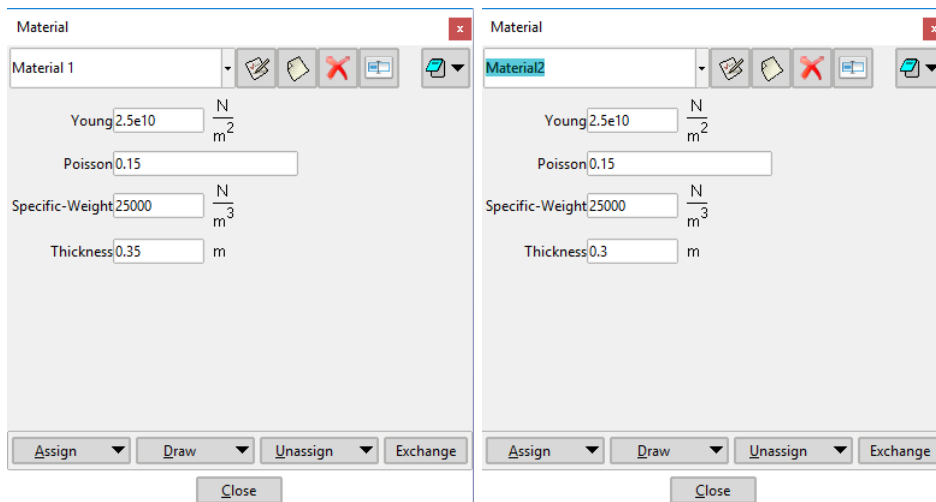

(a)

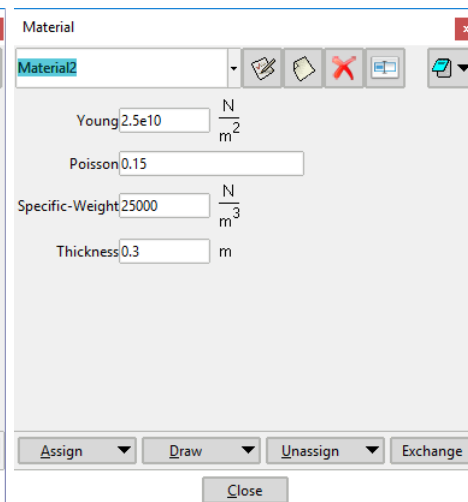

(b)

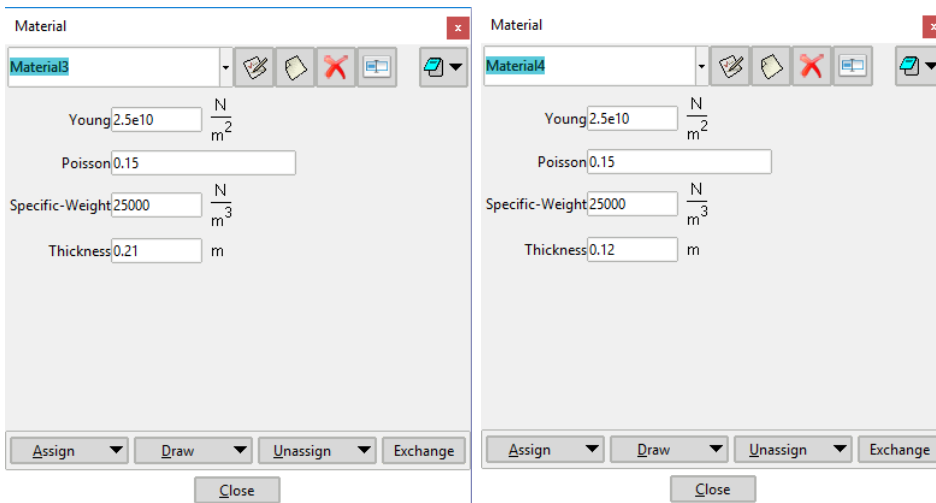

(c)

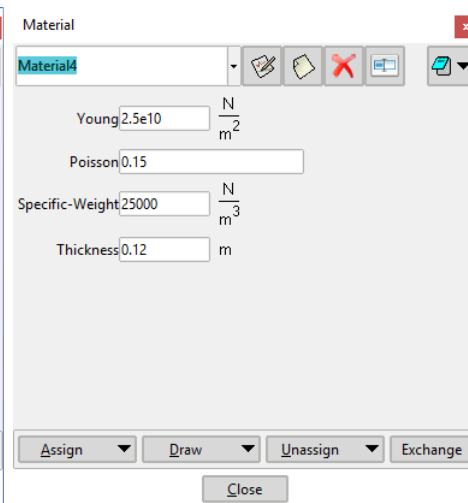

(d)

Figure 1.5: Definition of the different materials needed to correctly apply the different thickness of the shell.

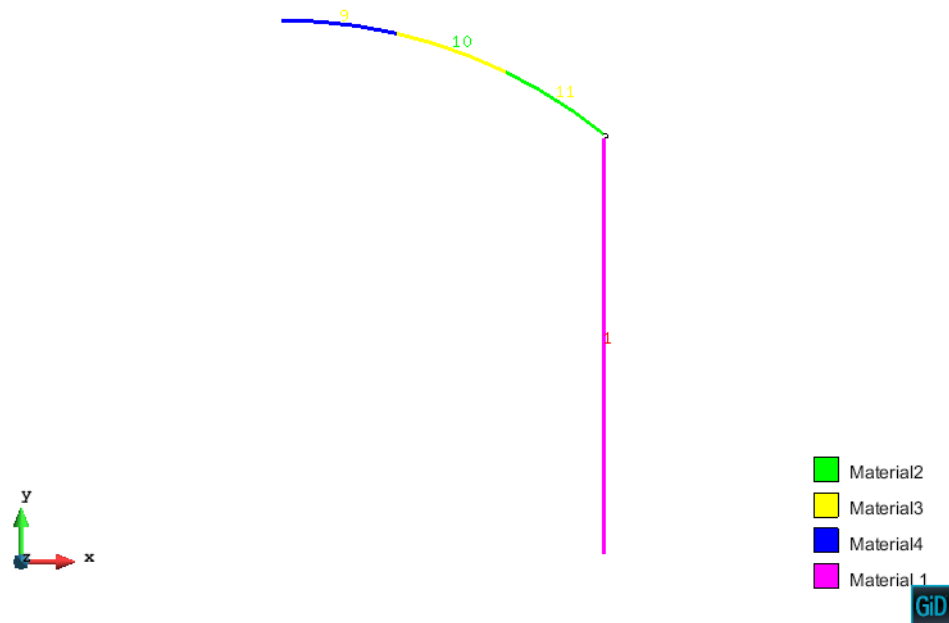

Figure 1.6: Materials with different thickness applied to Exercise # 1.

### Problem Data

In this section we specify some additional data required for the analysis.

- Problem title: Exercise1
- ASCII Output: No
- Consider self weight: Yes
- Scale factor: 1.0
- Result Units: N-m-kg

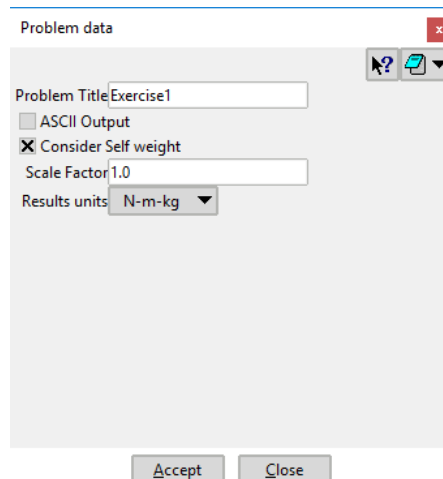

Figure 1.7: Problem data definition for Exercise # 1.

## Mesh

We consider the following mesh for the simulation. Note that the mesh is composed of "line" elements.

- Element type: revolutions shell elements with two nodes.

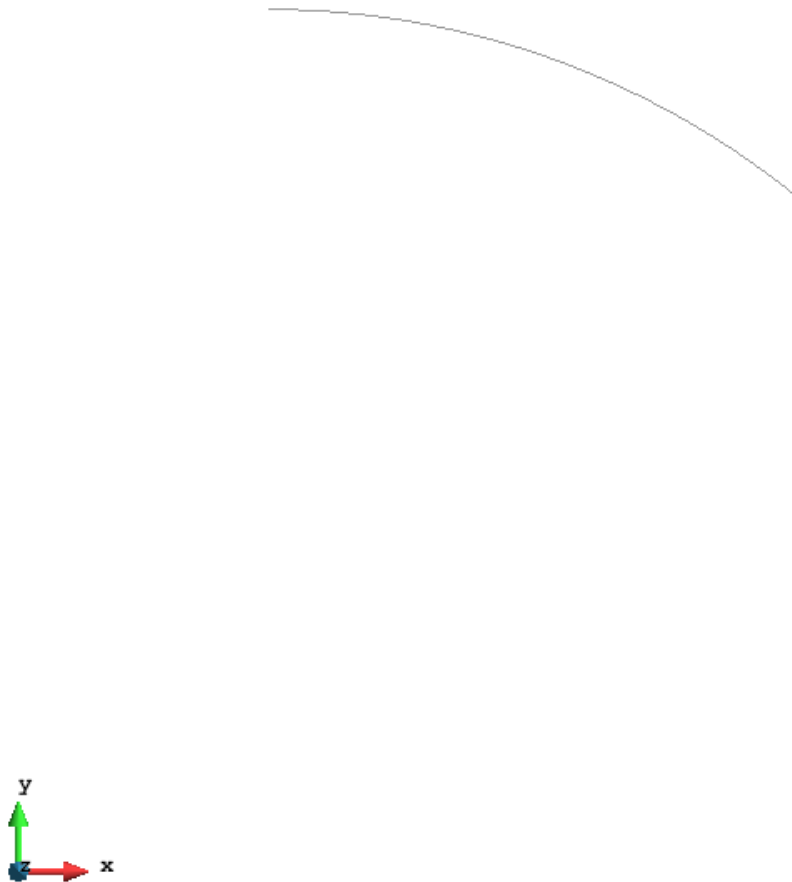

Figure 1.8: Mesh of revolution shells elements with two nodes.

### 1.2.2 Processing

Once the problem is fully defined we can proceed with the simulation. Figure down below is just a representation in GiD of the problem to be solved.



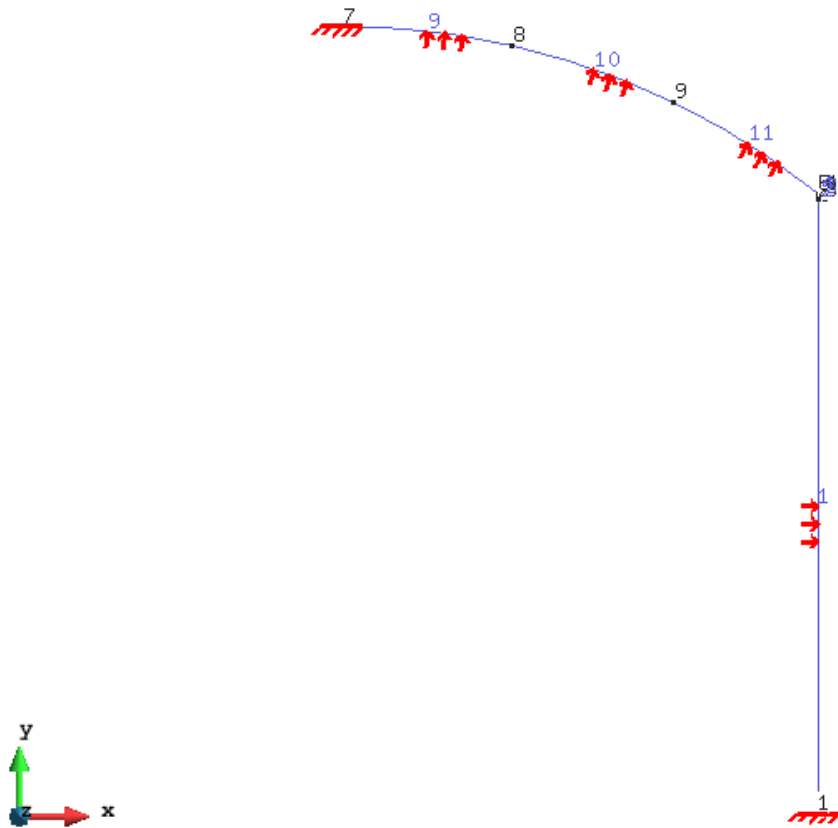

Figure 1.9: Exercise # 1 completely defined in GiD.

### 1.2.3 Results

The following Figures down below, show the results obtained after run the simulation. First, we include results on the displacement, just to check that our results appear to make sense. Then, we present results for the stresses and include a short discussion.

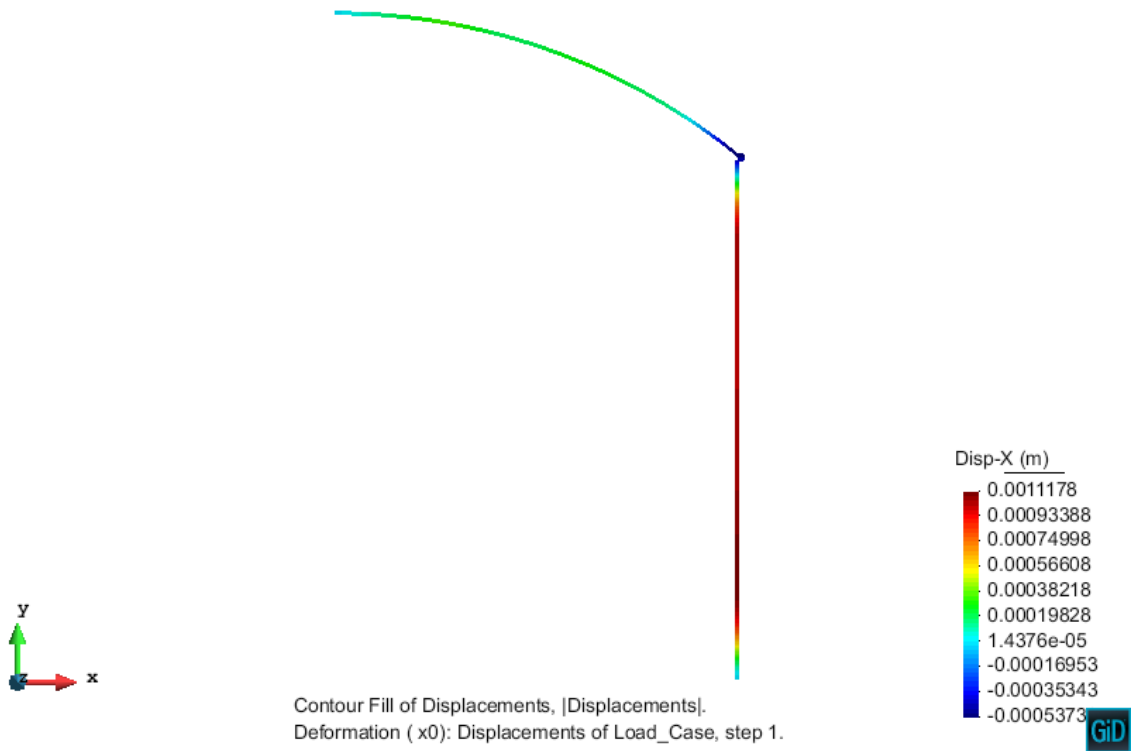

Figure 1.10: Displacements in the  $x$  direction.

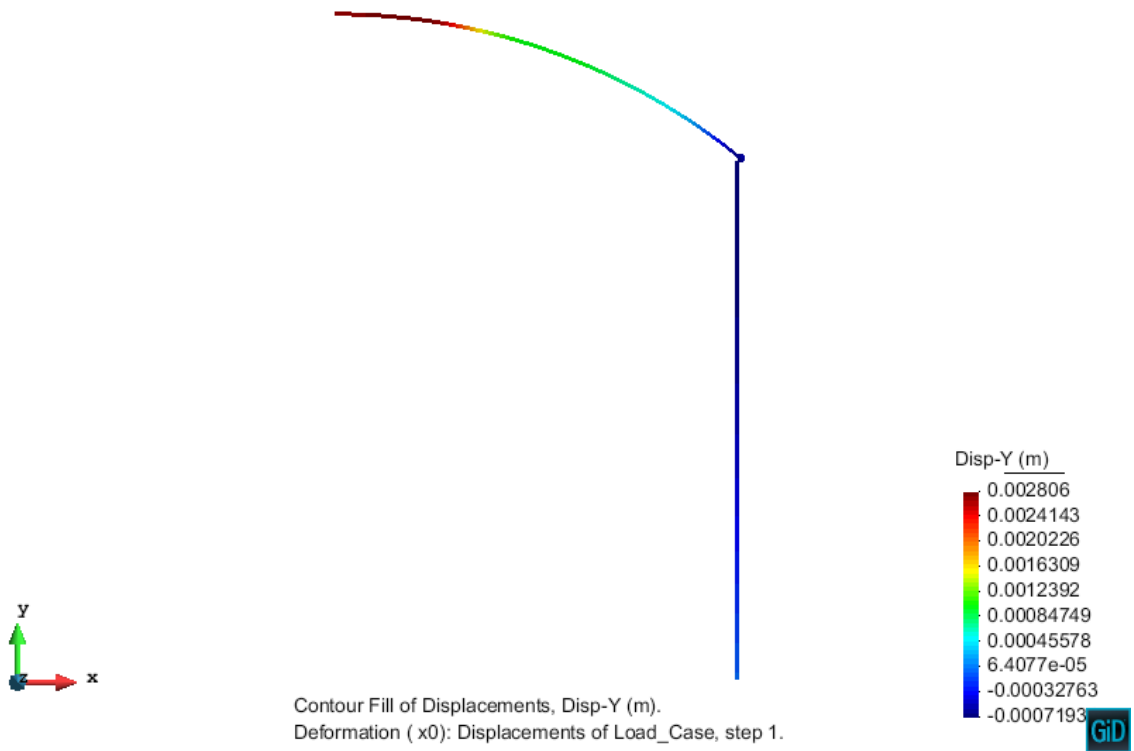

Figure 1.11: Displacements in the  $y$  direction.



Figure 1.12: Deformed shape of the tank.

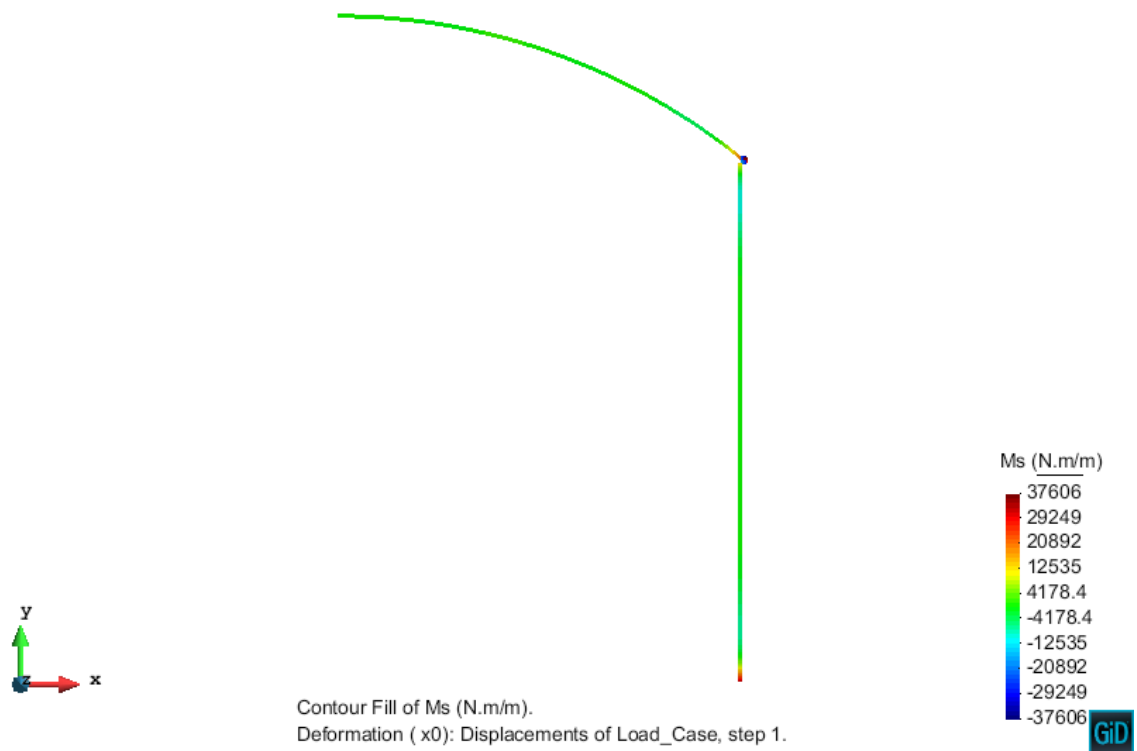

Figure 1.13: Results obtained for the integrated bending stresses in the  $s$  direction.

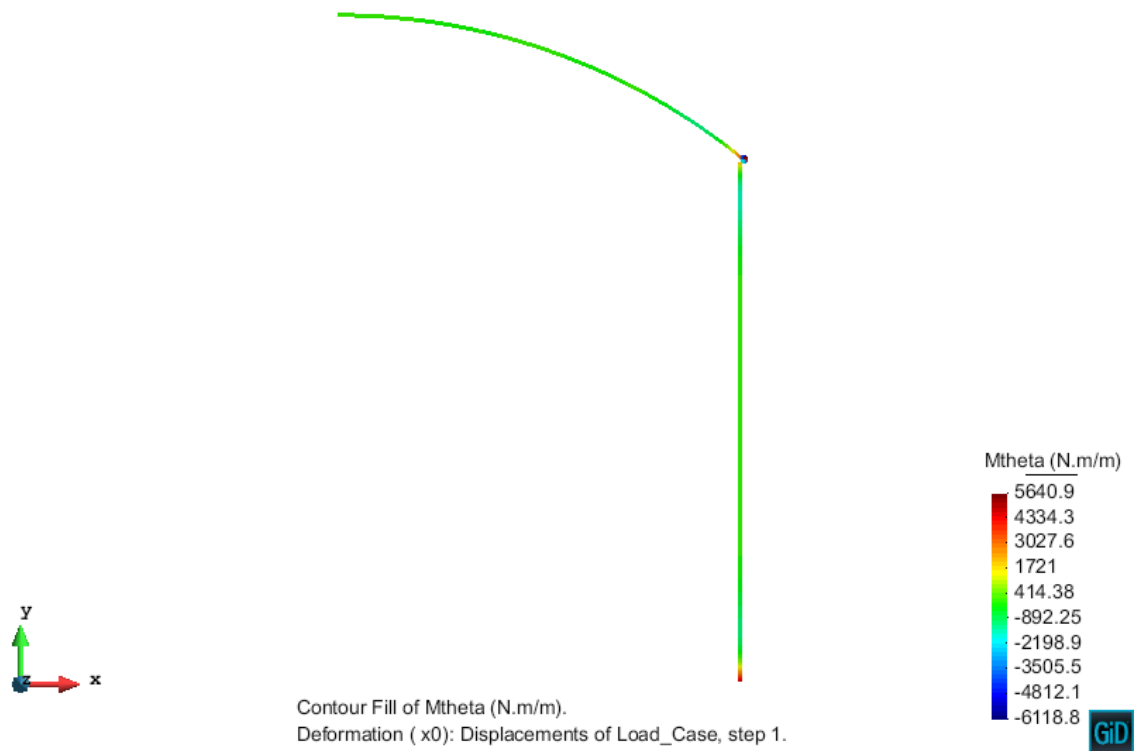

Figure 1.14: Results obtained for the integrated bending stresses in the prismatic direction.

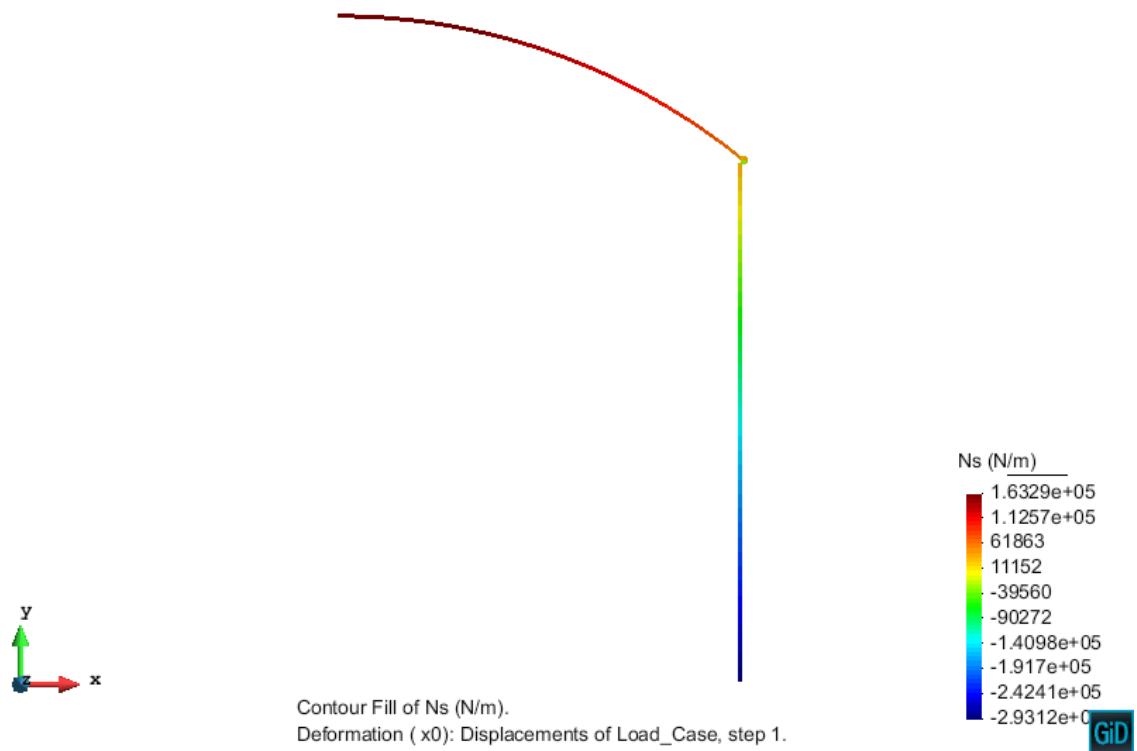

Figure 1.15: Results obtained for the integrated axial (membrane) stresses in the  $s$  direction.

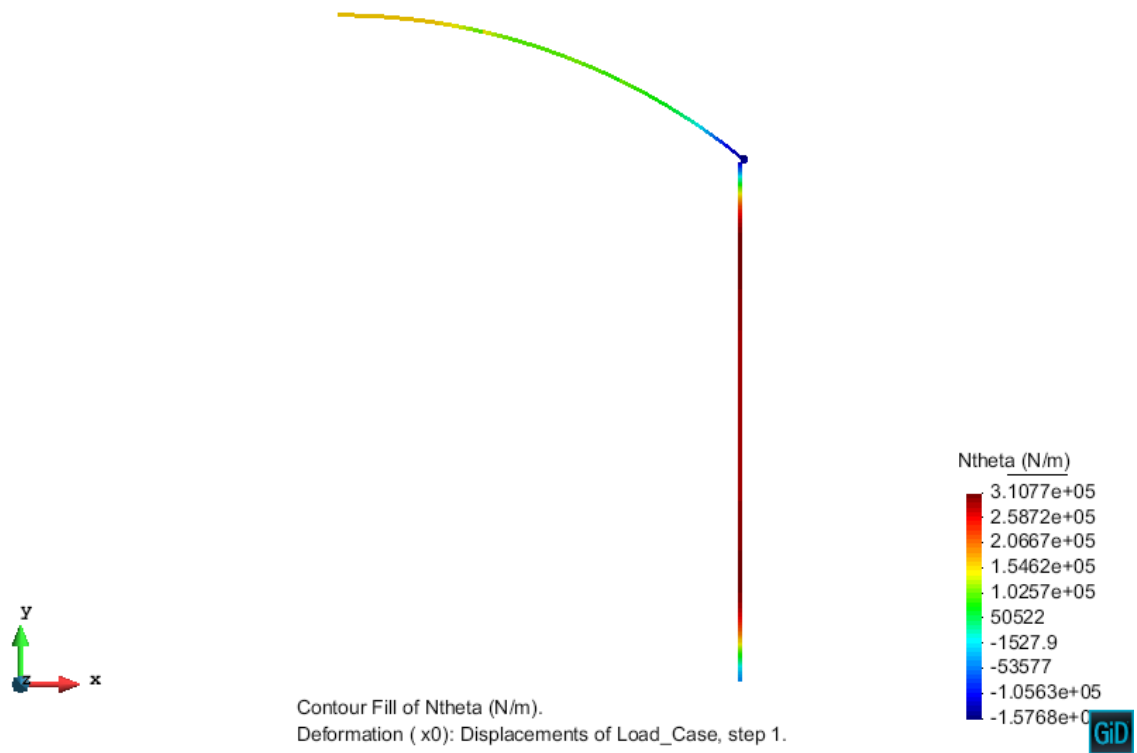

Figure 1.16: Results obtained for the integrated axial (membrane) stresses in the prismatic direction.

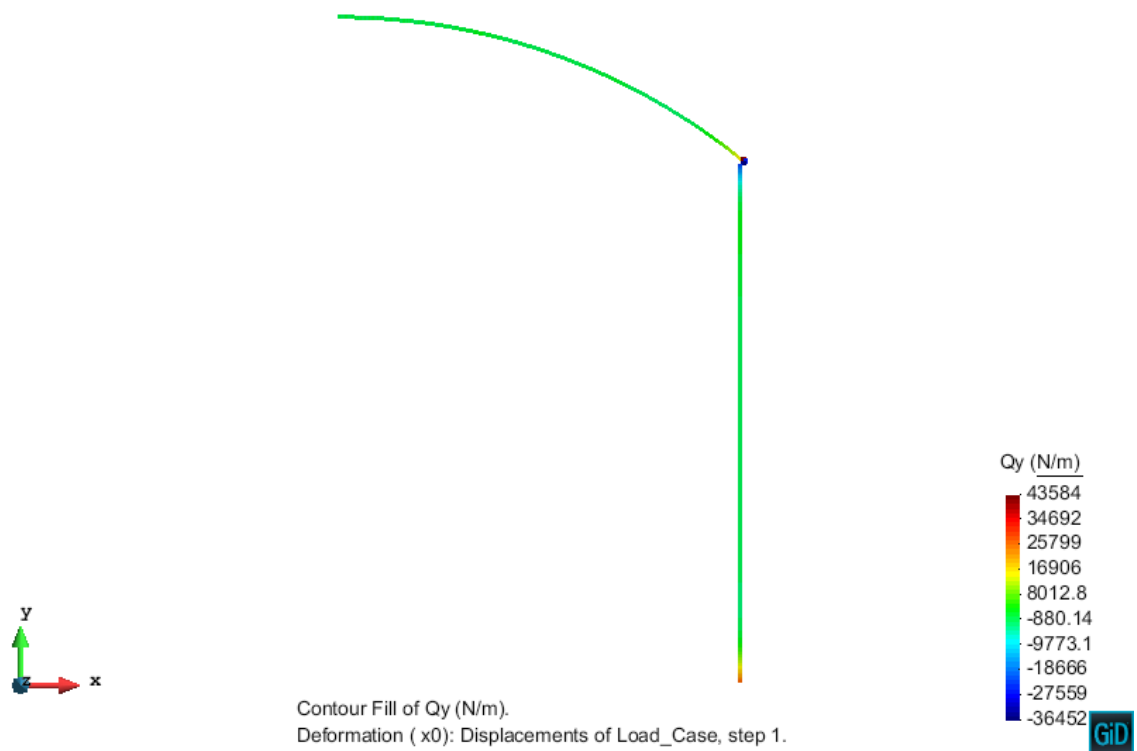

Figure 1.17: Results obtained for the transverse shear.

Figure 1.10 shows the displacements in the  $x$  direction. As one can tell, the right part of the tank is the one experiencing the highest horizontal displacements as a result of the pressure applied. In the case of displacements in the  $y$  direction, the part undergoing highest vertical displacement is the one corresponding to the dome of the tank, as we can see in Figure 1.11. The right part of the tank has a almost null displacement in this direction, as the pressure is applied perpendicularly to that surface. This explanations can be visually observed in Figure 1.12, which displays the deformed shape of the tank.

In the case of the local bending stresses, both  $M_s$  and  $M_{theta}$  basically concentrate on the adjoint of the dome with the cylindrical part of the tank, Figures 1.13, 1.14. This a typical behavior of the shell structures. Note that this is the part with abrupt changes in the geometry, which are well-known points of stress concentration. On the other hand, axial stress show a more distributed behavior. It is noticeable the fact that the membrane stresses in the prismatic direction are higher in the cylindrical part while remain lower in the dome. Finally, Figure 1.17 offers the results obtained for the shear stresses. Again, higher values appear of the joint of both parts of the tank, which is the critical zone. It is also remarkable how this shear stresses reach a high value near the inelastic joint in the ground, which is the point with more restriction in the geometry.

In the next section, we present the procedure followed to compute the solution using the 3D elements, with a discussion and comparison of the results with those obtained in with revolution shell elements.

## 2 Exercise # 2: Cylindrical tank analyzed with 3D shell elements

### 2.1 Purpose of the example

In this second exercise the goal is to analyze the state of stress of the same cylindrical tank modeled in Exercise 1 but using 3D shell elements in Tdyn.

### 2.2 Analysis

#### 2.2.1 Preprocessing

##### Geometry

First, we define the geometry using the GiD sketcher tool.

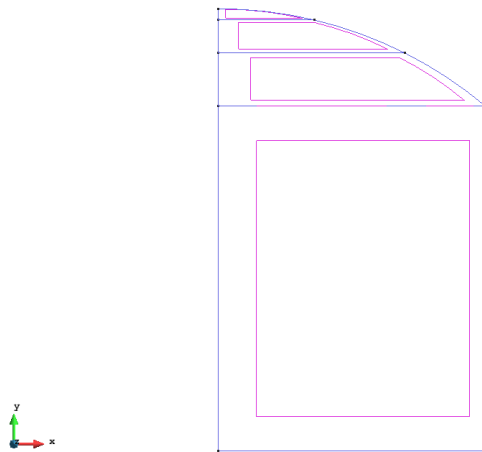

Figure 2.1: Geometry of the cylindrical tank.

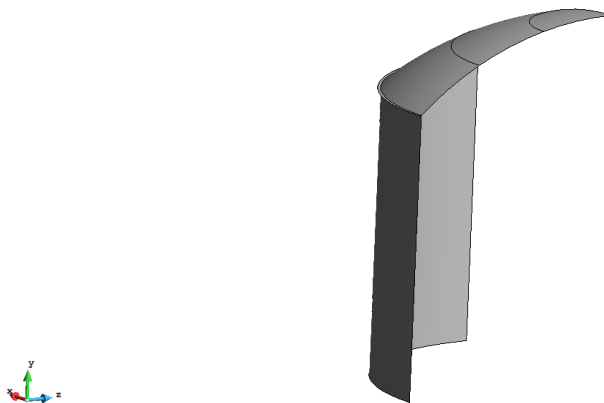

Figure 2.2: Geometry of the cylindrical tank.

It is important to note that we just need to define surfaces. Thickness will be provided later in the material section. The top curved part is divided into three parts so a progressively changing thickness can be modeled. Only a quarter of the geometry is modeled as symmetry can be considered to reduce the computations.

## Data

### General Data

Once the geometry is defined, we can now choose the type of problem that must be solved from the options given in *Tdyn*. For this case, we are dealing with 3D shells. Thus, we choose to do a structural analysis, using the international unit system, considering gravity in the negative Y direction and using 3D shells. The type of analysis is static and the materials and boundary conditions are linear.

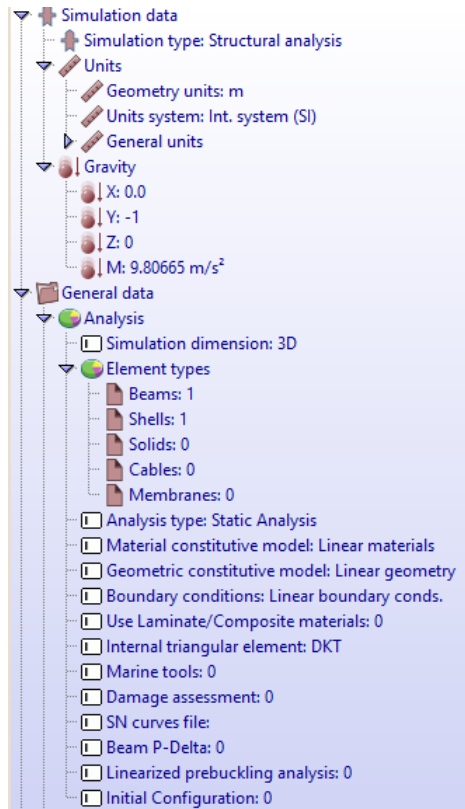

Figure 2.3: General data for the problem

### Boundary conditions

The type of boundary conditions that are considered in this example are the following:

- Symmetry conditions applied in the edges where the model is cut in order to properly account for the rest of the structure. In the XY plane the model cannot move in the Z direction and cannot rotate in X or Y. In the YZ plane the model cannot move in the X direction and cannot rotate in Y or Z.



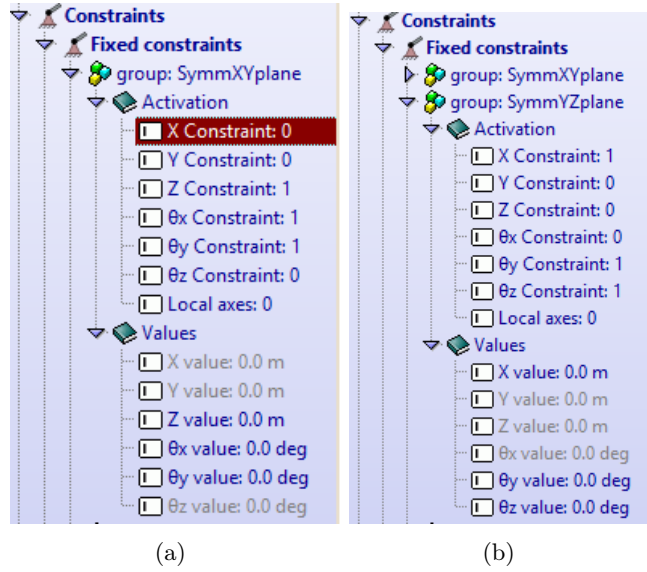

Figure 2.4: (a) Definition of symmetry conditions in the XY plane and (b) Definition of symmetry conditions in the YZ plane

- Load / Uniform Load : a uniform distributed load of value  $p = 1.0e4 \text{ N/m}^2$  is considered acting uniformly on the whole shell. It is important to check the definition of the normal on the shell, so that the pressure is applied in the correct direction.

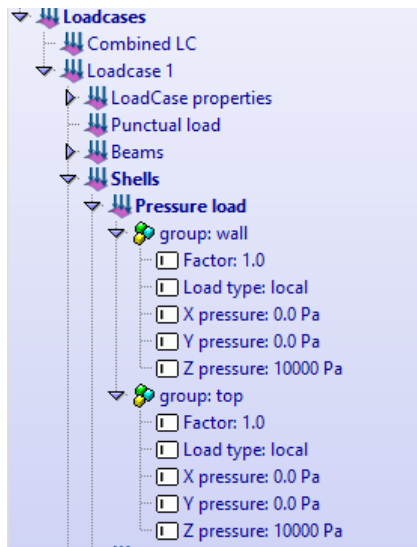

Figure 2.5: (a) Definition of the loading.

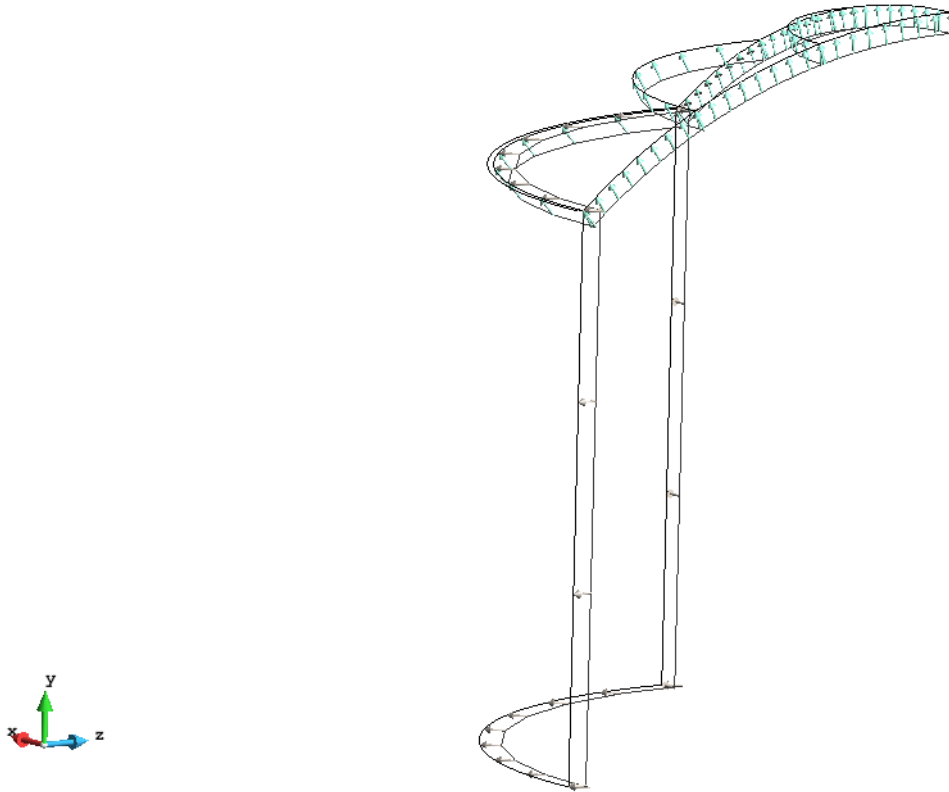

Figure 2.6: (Representation of the pressure applied

### Material

The tank is made of a material with the following mechanical characteristics:

$$E = 2.50e10 \text{ N/m}^2 \quad ; \quad \nu = 0.15 \quad ; \quad \gamma = 25000 \text{ N/m}^3$$

Now we need to define different materials in order to apply the different thickness of the shells. The curved part has been divided into three parts or groups with thickness  $t = 0.3$  (top1),  $t = 0.21$  (top2) and  $t = 0.12$  (top3) in order to simulate the thickness transition from the wall to the center. The vertical wall has a constant thickness of  $t = 0.35$  (wallmaterial).

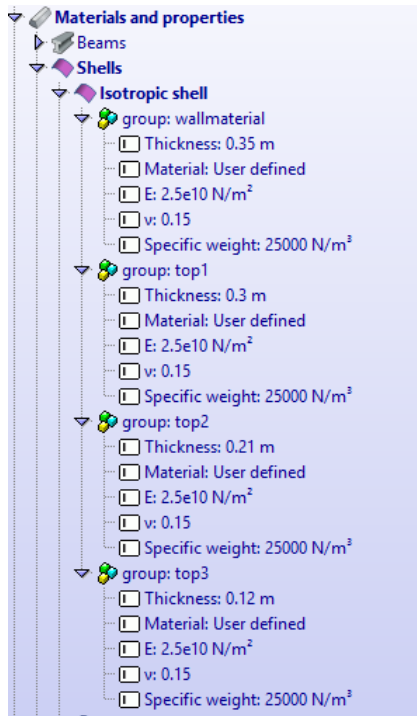

Figure 2.7: Definition of the different materials needed to correctly apply the different thickness of the shell.

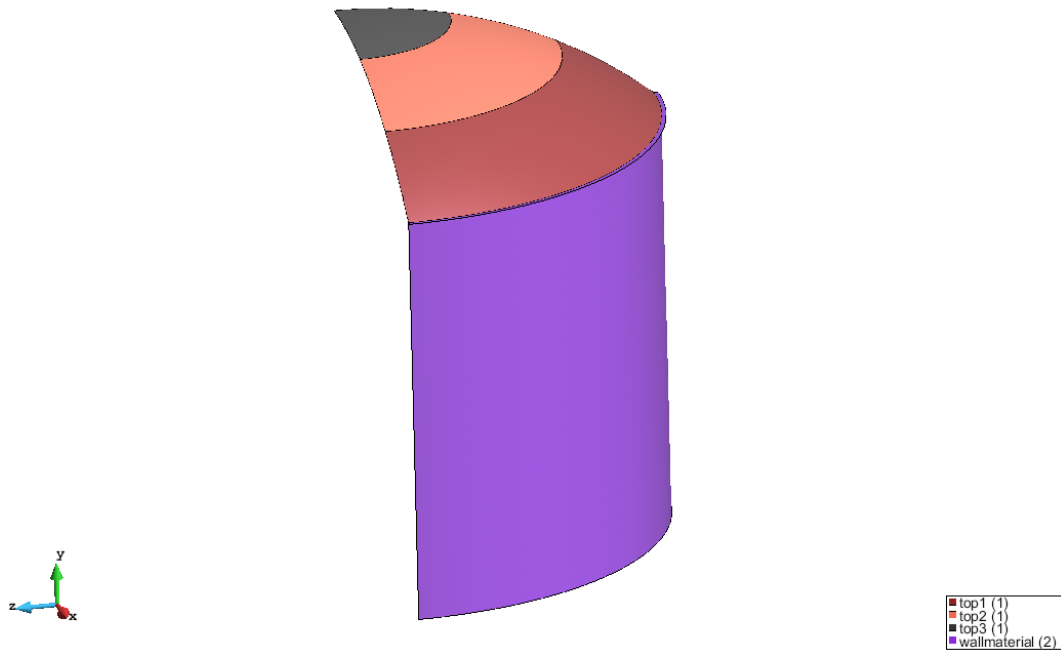

Figure 2.8: Assignment of the different materials to each section.

### Mesh

For the simulation, linear triangular shell elements are used. An unstructured mesh is generated using: the following options

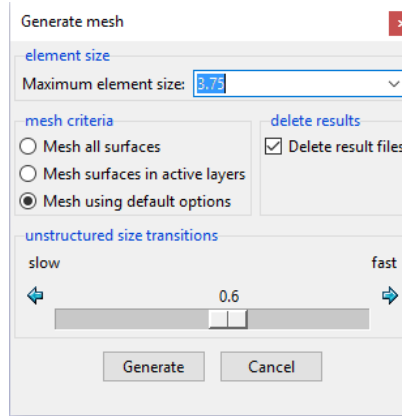

Figure 2.9: Options for the generation of mesh

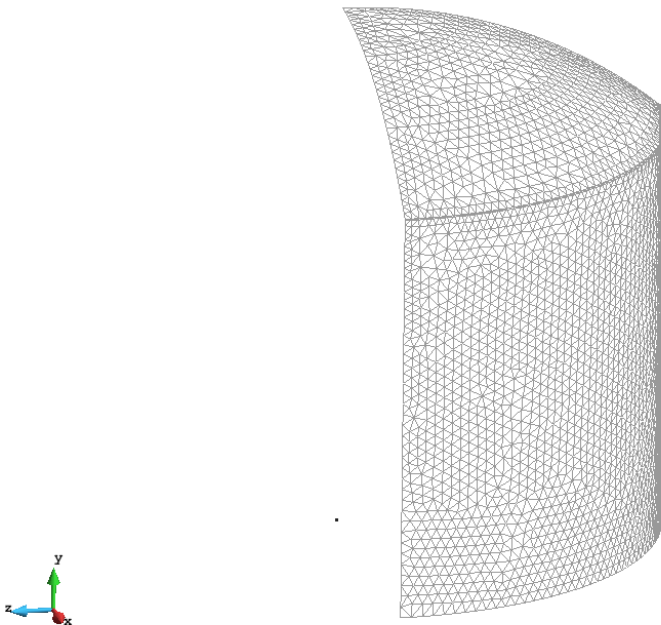

Figure 2.10: Generated mesh

## 2.2.2 Processing

Once the problem is fully defined we can proceed with the simulation.

## 2.2.3 Results

The following Figures down below, show the results obtained after running the simulation. We will proceed to compare the obtained results with the ones obtained for the revolution shell analysis.

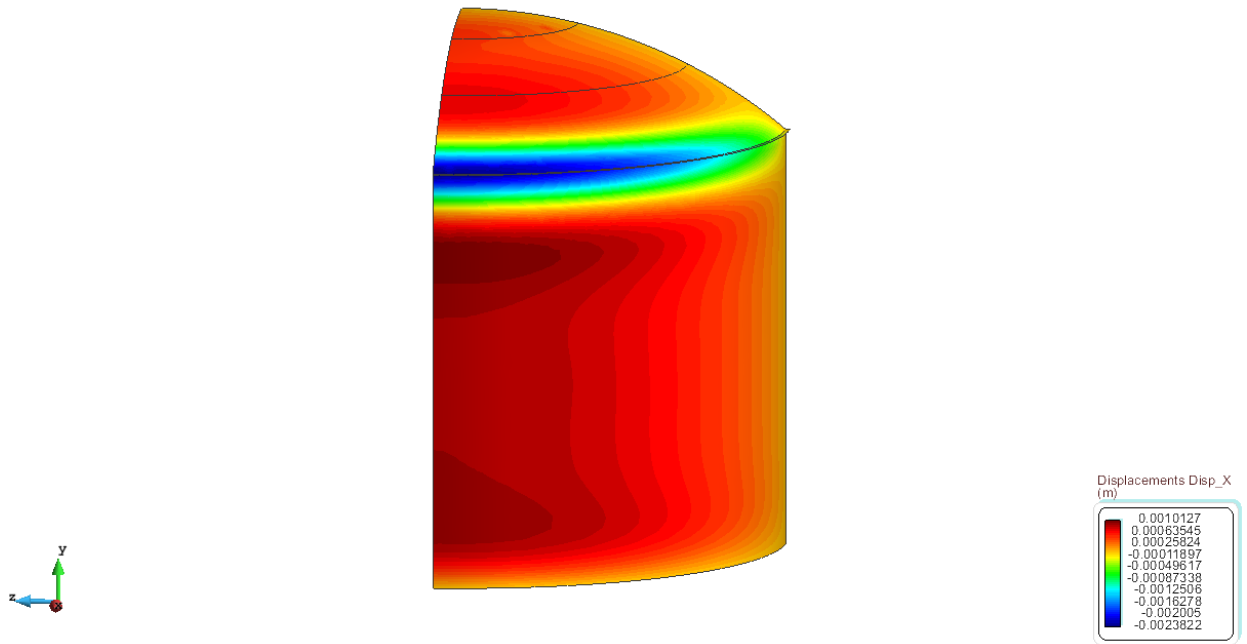

Figure 2.11: Displacements in the  $x$  direction.

The distribution of the displacement in the  $x$  direction obtained for the 3D analysis is similar to the one obtained in the 2D revolution analysis. The maximum displacement is located in the same area for both cases, in the center of the vertical wall. This result is expected, as the pressure in the inside on this wall will make it bend. The difference between the maximum  $x$  displacement value for the 3D and the maximum  $x$  displacement for the 2D is about 10%. Then the results for both analysis seem to be consistent.

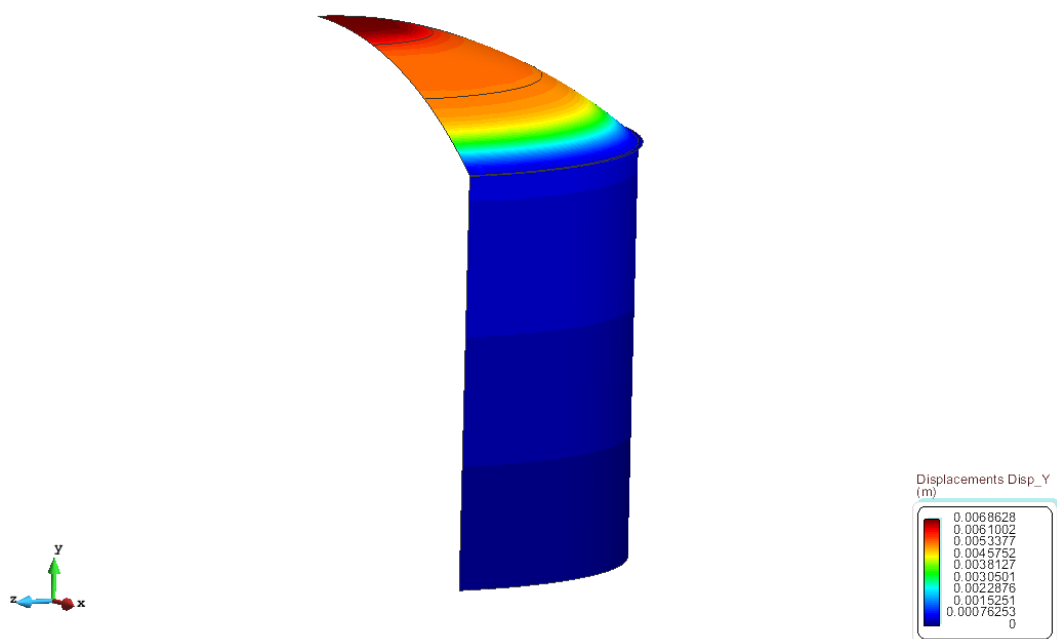

Figure 2.12: Displacements in the  $y$  direction.

The distribution of the displacement in the  $y$  direction is also equivalent for both analysis. The structure has zero displacement in the base and then it grows when moving upwards until reaching the maximum in the center of the top curved part. This is also expected, as the pressure does not have any  $y$  component acting on the vertical walls. The difference between the maximum  $y$  displacement in both analysis is of 47%, with the value of the displacement in the 3D case being higher than the 2D case. This can be due to the fact that the revolution analysis is more restricted and subjected to more hypothesis in order to fulfill all the symmetry conditions, thus this can cause that the structure has less freedom and more restrictions than it should.

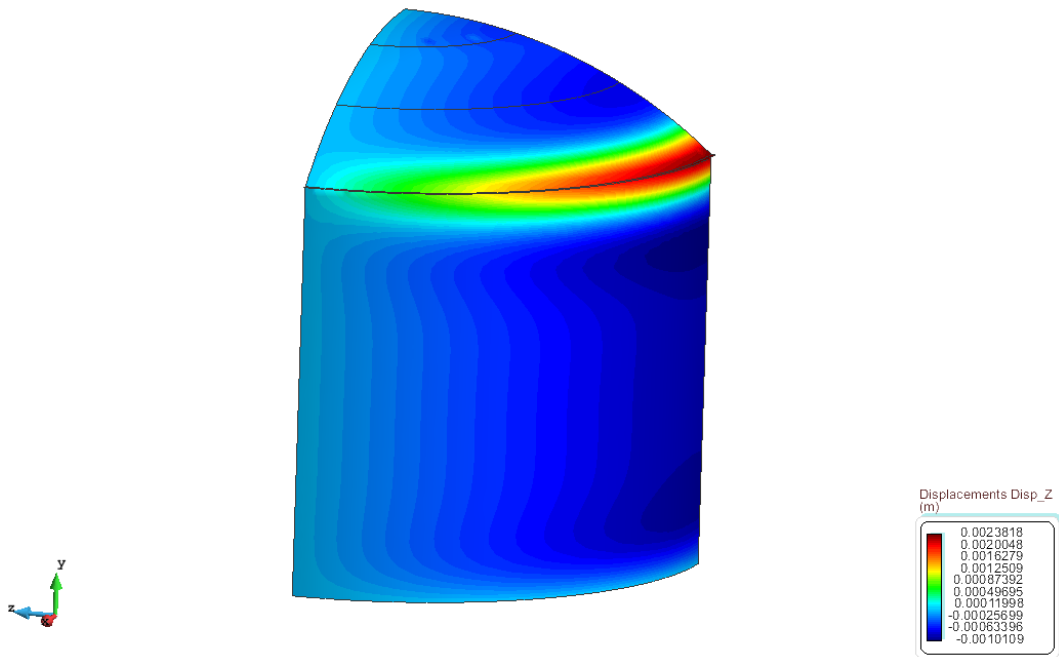

Figure 2.13: Displacements in the  $z$  direction.

The displacement in the  $z$  direction is not comparable as this dimension is not present in a 2D analysis. The displacement field seems to be consistent with the one obtained for the  $x$  displacement, following the same type of distribution.

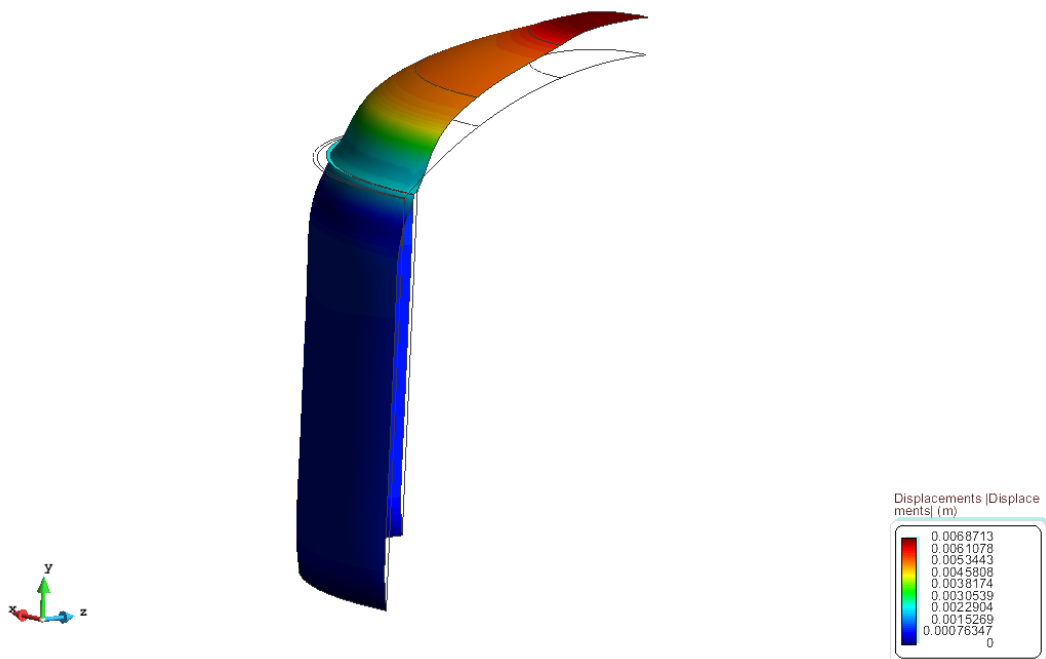

Figure 2.14: Deformed shape of the tank with an scale factor of 500.

All the results of the displacement fields commented before can be visually observed in Figure 2.14, which displays the deformed shape of the tank. The dome basically moves vertically and the wall slightly curves to the outside.

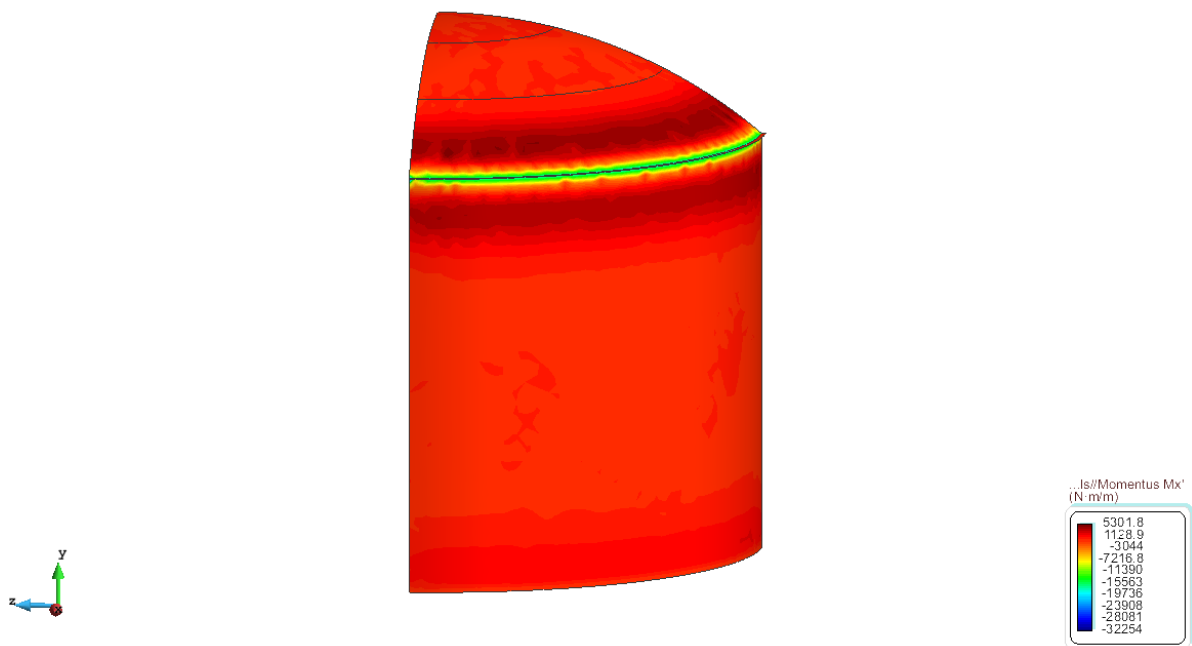

Figure 2.15: Results obtained for the integrated bending stresses in the  $x$  direction.

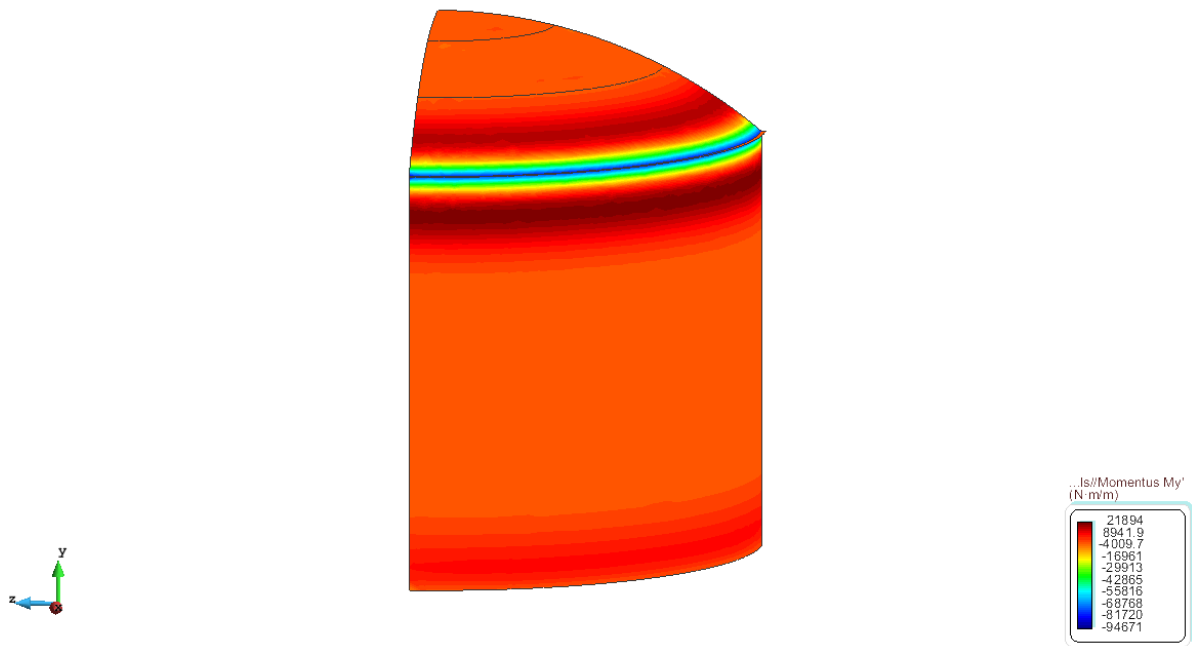

Figure 2.16: Results obtained for the integrated bending stresses in the  $y$  direction.

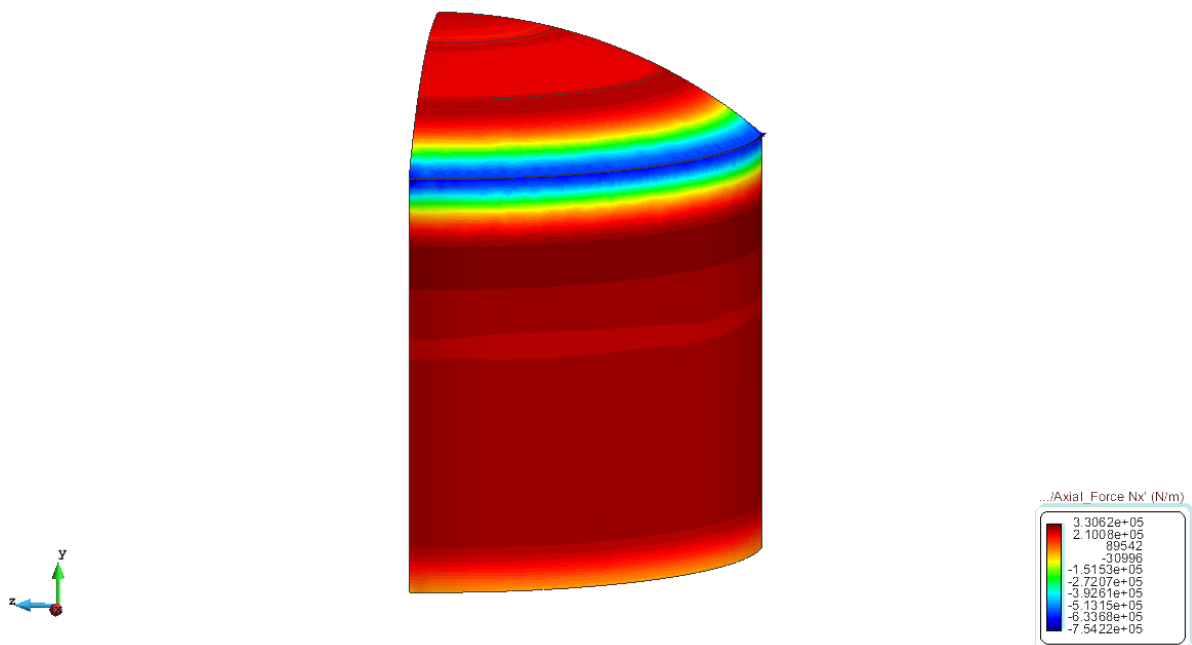

Figure 2.17: Results obtained for the integrated axial (membrane) stresses in the  $x$  direction.



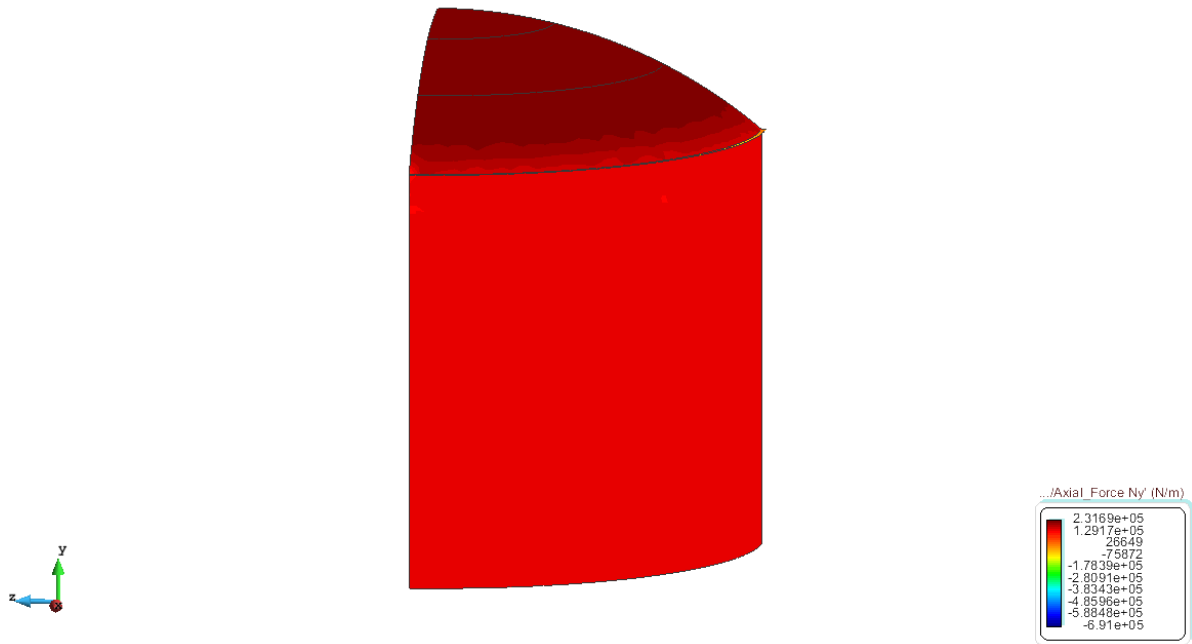

Figure 2.18: Results obtained for the integrated axial (membrane) stresses in the  $y$  direction.

In the case of the local bending stresses, both  $M_x$  and  $M_y$  concentrate on the adjoint of the dome with the cylindrical part of the tank, exactly as happened in the 2D analysis, and that can be seen in Figures 2.15 and 2.16. That transition is an abrupt change in the geometry, that obviously acts as a stress concentration.

On the other hand, axial stresses show a more distributed behavior, the same as in the 2D case. It is interesting to notice that the vertical wall has a perfectly evenly distributed axial stress in the  $y$  direction, caused by the type of load applied. Because of the direction of the pressure applied, the vertical wall supports the maximum axial stress in the  $x$  direction.