

**Numerical investigation of a premixed swirling
combustor in adiabatic conditions using large-eddy
simulation**

Author: Artemii Sattarov



**Advisor:
Daniel Mira**

September 25, 2016

1. Introduction

1.1. Motivation

Combustion is one of the most important industrial processes of modern mechanical and aerospace engineering. As most of the energy in the world is obtained through combustion [1], the optimization of this process can increase energy production, provide better performance of energy conversion and decrease environmental footprint.

Nowadays, numerical simulations using high performance computing (HPC) are widely used to model systems of the aerospace industry. The use of simulations for the design and development of combustion systems demands experimental data, so that the models can be tested and improved to obtain accurate predictions without conducting experimental measurements. In particular, the project is focused on the modelling of a swirling combustor for which extensive data is available. The experimental and numerical data were obtained in the framework of the Prediction and Control of Combustion Instabilities in Industrial Gas Turbines (PRECCINSTA) EC funded project. Therefore, the PRECCINSTA combustor is an excellent test case and has been widely used to validate new combustion models [2].

1.2. Objectives

The primary purpose of the project is to benchmark and assess the accuracy of a turbulent combustion model based on tabulated chemistry for premixed combustion in the flamelet regime using the multiphysics code Alya.

A realistic swirling combustor so-called PRECCINSTA is utilized for the benchmark. It is an experimental facility at German Aerospace Center (DLR) and is currently used as a configuration for validation of turbulent combustion models.

The Alya code was used for the purposes of the project. Alya involves CFD module of the PRACE Benchmark Suite for HPC applications and had been tested and optimized in most European supercomputer centers.

The activities of the project were focused on these key areas:

- Scalability and efficiency of the code when running non-reacting and reacting applications to evaluate the cost of the access to the look-up tables where the chemistry is stored;
- Comparison with experimental data for mean and fluctuating values of velocity and scalars in the premixed regime for adiabatic conditions. The comparison will be addressed for both Reynolds-averaged Navier-Stokes (RANS) and Large Eddy Simulations (LES) approaches;

Before the turbulent burner is simulated, the physical problem and numerical strategies are discussed and tested for laminar premixed flames. The mixture under investigation belongs to a stable and lean flammability range.

The report is structured as follows: the Section 2 is devoted to simulation and verification of 1D laminar premixed flames. The numerical setup in Alya is also introduced. In the Section 3 the investigated geometry, computational grids, numerical setups and results of RANS and LES simulations of the swirling combustor are presented. The comparison with experimental and numerical results are addressed in this chapter.

2. One-dimensional laminar premixed flame

2.1. Physical description

The problem to be solved is a premixed, freely propagating, steady, laminar flame. This system is characterized by a premixed mixture of fuel and air entering the reaction zone where it reacts chemically. The overall chemical reaction is given by:

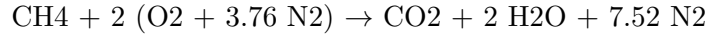

The equations being solved correspond to the low Mach number approximation of the Navier-Stokes equations for multispecies reactive flows with mixture-averaged multicomponent properties. In this case, the system is governed by the transport equations of continuity and momentum, along with the transport of the reaction progress variable to represent the thermochemical state of the chemical problem and the energy equation expressed in terms of the total enthalpy. The system is closed by the equation of state.

The purpose of this investigation is to find the properties of the combustion products for a steady state calculation knowing the conditions of the incoming mixture. A sketch of the system in a one-dimensional domain is given in Figure 2.

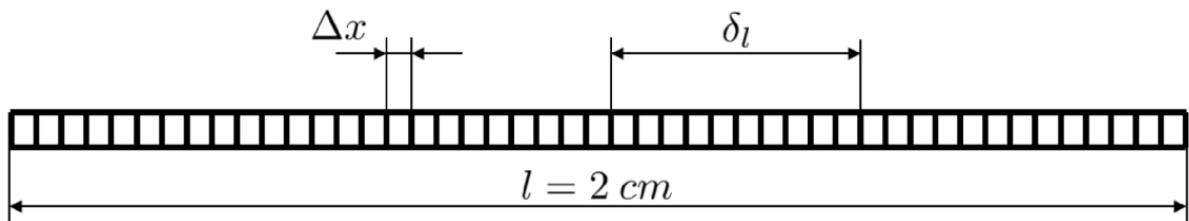

Figure 2: Computational domain for a one-dimensional flame

2.2. Numerical setup

The following Alya input files are used for the 1D Laminar flame simulation:

- testcase.dat — General input file;
- testcase.ker.dat — Kernel file;
- testcase.dom.dat — Domain file;
- testcase.nsi.dat — Incompressible flows (Nastin) file;
- testcase.tem.dat — Thermal flows (Temper) file;
- testcase.chm.dat — Species transport and chemical reactions (Chemic) file;
- testcase.post.alyadat — File, which is used for postprocessing.

The general simulation parameters were defined in the above-mentioned files. In order to use a created mesh in the simulation the paths for *.dims.dat*, *.geo.dat* and *.fx.bou* files were included in Dimensions, Geometry and Sets sections of the Domain file. The number of time steps was specified in General input file. Postprocess output interval was controlled using the Kernel file.

A turbulence file *.tur.dat* can be added in order to study turbulent combustion using RANS models.

2.2.1. Initial conditions

The initial conditions correspond to a situation of unburnt and burnt products separated in the center of the computational domain. An example is given in Figure 3.

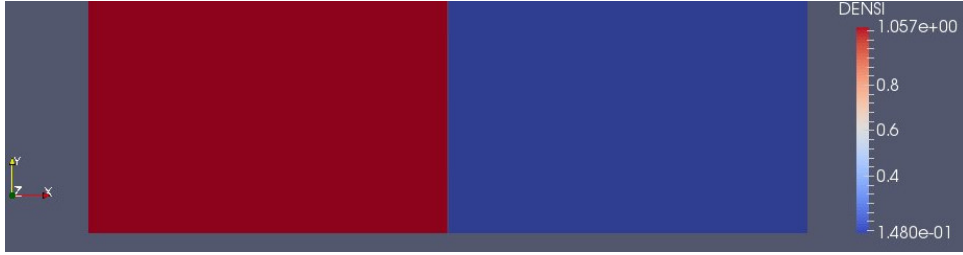

Figure 3: Initial conditions for one-dimensional flame

The fuel mass fractions for the tested equivalence ratios were found using the following expression [3]:

$$Y_{CH_4} = \frac{1}{1 + \frac{s}{\phi} \cdot (1 + a \cdot \frac{W_{N_2}}{W_{O_2}})}$$

, where $a = 3.76$. The value comes from atmosphere conditions assuming a two-component mixture.

An example of the initial conditions for burnt and unburnt mixture are given in Table 1 and are used to initialize the domain.

Variable	Unburnt conditions	Burnt conditions
Velocity	$u = 0.288\text{m/s}$	$u = 2.0626\text{m/s}$
Density	$\rho = 1.05656\text{m/s}$	$\rho = 0.15\text{m/s}$
Temperature	$T = 320\text{K}$	$T = 2200\text{K}$
Pressure	$p = 101325\text{Pa}$	$p = 101325\text{Pa}$
Y_{CH_4} (Fuel)	0.04983	0.0

Table 1: Burnt and unburnt initial conditions for $\phi = 0.9$

Initial condition files are created by executing a python script indicating the path to the mesh *.dat* file. This file requires the following input parameters: pressure for the whole domain \mathbf{p} , ideal gas constant \mathbf{R} , inlet velocity \mathbf{u} . The file is designed to create initial conditions for non-premixed conditions, that is why even for premixed cases, it is necessary to input molar weights and temperatures for 2 different mixtures. In practice, the premixed case is just one entry (or flamelet) from the non-premixed database. In addition, NASA polynomial values are taken from the tabulation database in order to approximate the integral and calculate enthalpy value. After this, the mixture fraction, which corresponds to the desired equivalence ratio, should be added. Based on the mixture fraction and the transport properties from the individual components, the mixture-averaged properties can be obtained. The conservation of mass is used to calculate the initial conditions in the burnt side of the computational domain that is downstream the flame front.

This command creates *.alya* format files with the desired initial conditions. In our case the created files are namely:

- CON01.alya — reaction progress variable, 0 for the unburnt mixture, 1 for the burnt mixture;

- CON02.alya — variance of the reaction progress variable, must be set to 0 for the whole domain, since no turbulence effects are considered;
- CON03.alya — mixture fraction, remains constant for the whole domain;
- CON04.alya — variance of the mixture fraction. Must be set to zero for the same reasons as CON02;
- VELOC.alya — initial condition for the velocity;
- ENTHA.alya — initial condition for the enthalpy, constant for the whole domain;
- TEMPE.alya — initial condition for the temperature.

Some of the above mentioned files provide initial conditions with a jump at the center of the domain. However, a smoother transition could be considered to increase convergence, though is not mandatory.

The files have a column structure with the first column indicating the node number and the second, indicating the value at the corresponding node.

2.2.2. Boundary conditions

The boundary conditions of this problem correspond to a premixed methane flame at equivalence ratios $\phi = 0.7, 0.83, 0.9, 1.0$ and 1.1 using the GRI 3.0 detailed mechanism [4].

The inlet conditions are imposed as Dirichlet-type and are given in Tables 2, 3, 4 and should be in compliance with the initial conditions indicated previously.

1 and 3	11	0.26	0.00
Joint node of wall and inlet	Fixed in x and y directions	$u = 0.288\text{m/s}$	$v = 0\text{m/s}$

Table 2: Boundary conditions for flow velocity in Nastin

1 and 3	1	0.04983
Joint node of wall and inlet	Fixed in x direction	$Y_{CH_4} = 0.04983$

Table 3: Boundary conditions for the composition in Chemic

1 and 3	1	320
Joint node of wall and inlet	Fixed in x direction	set temperature $T = 320$

Table 4: Boundary conditions for temperature in Temper

The *outlet boundary conditions* are of Neumann-type of the corresponding variables, where all fluxes are set equal to zero.

2.3. Simulations and results

After creation of all necessary initial condition files and modification of Alya input files, individual solutions for each equivalence ratio were obtained. In order to start the calculation, the bash script, see Table 5, is executed on the terminal.

```

BSUB -n 16
BSUB -R"span[ptile=16]"
BSUB -o output.out
BSUB -e output.err
BSUB -J ER 1
BSUB -W 00:40
mpirun /gpf/projects/bsc21/bsc21734/svn/Alya/Executables/unix/Alya.x cfi1d

```

Table 5: Shell script

During the simulation the convergence was checked using the built-in Alya commands, see Figure 4. In case residuals of the order of at least 10^{-2} for continuity and 10^{-4} for momentum equations are not reached, the Safety factor in Alya input files and consequently time step was decreased in order to reach convergence.

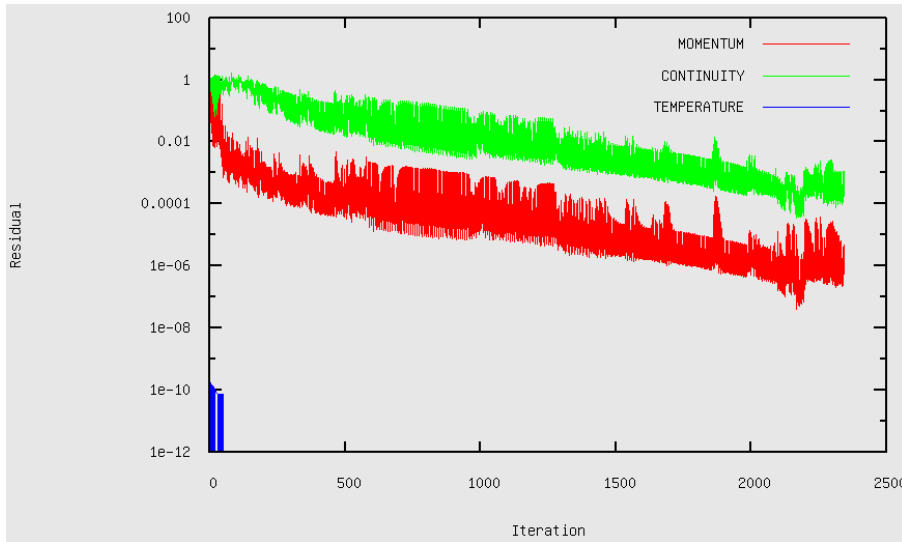

Figure 4: Residuals of continuity, momentum and energy equations

After getting the first result of the simulation with good convergence characteristics, the *alyabin* files were converted to *ensight* format in order to visualize the results in Paraview.

The variables were visualized using *Plot Over Line* function in Paraview. The flame movement can be effectively captured by taking values of a source term position coordinates at two different time steps. The interval between time steps should be large enough to decrease an error. The new guess for the velocity (this could also be referred as the laminar flame speed s_L) reads:

$$u_{new} = s_L = u + \frac{x_2 - x_1}{t_2 - t_1}$$

Having the result of a trial simulation, the correct values of the burnt gases velocity and density can be imposed in the initial conditions file.

The results obtained after application of the above-mentioned methodology to the simulation of different equivalence ratio flames are presented in Figure 5.

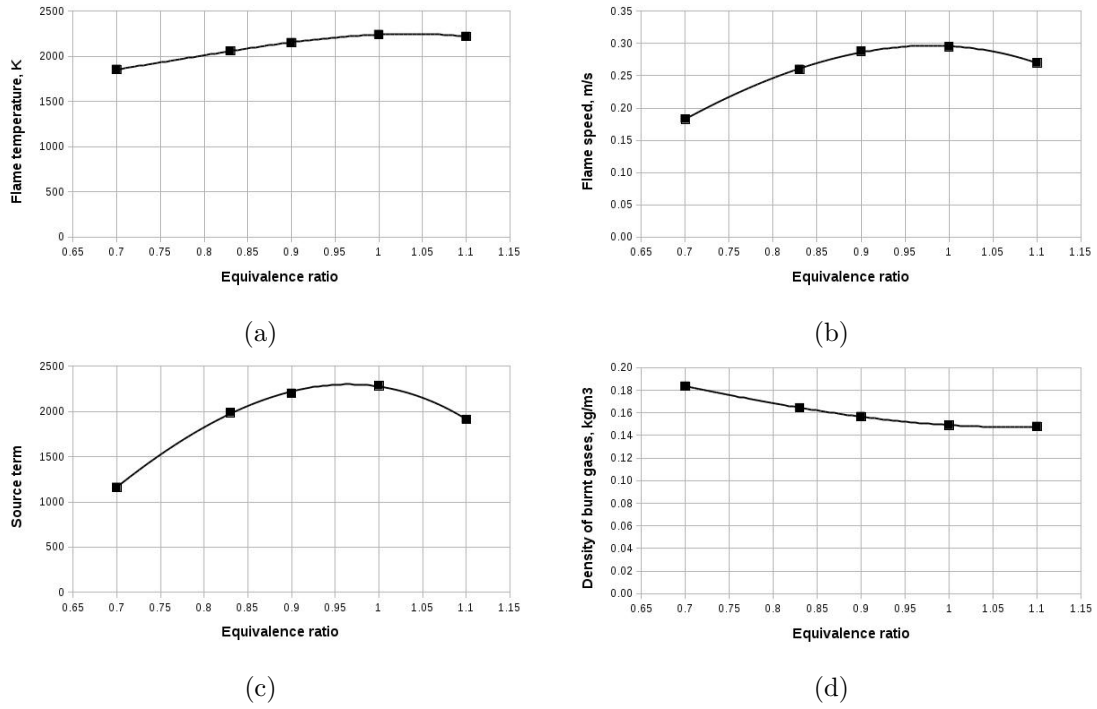

Figure 5: Laminar flame parameters: (a) Flame temperature; (b) Flame speed; (c) Source term value (d) Density of burnt gases

The temperature profiles for different equivalence ratios were compared using *Paraview* environment, see Figure 6.

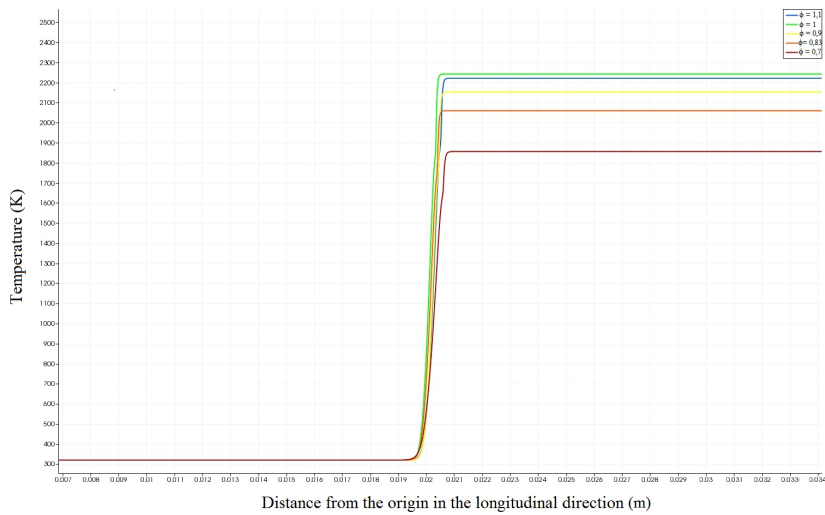

Figure 6: Temperature profiles for 1D flames with different equivalence ratios

2.4. Conclusions and recommendations

Distribution of the laminar flame parameters including temperature profiles for different equivalence ratios correspond to the theoretical values. This confirms and validates the thermochemical database that was provided at the start of the project.

The set of recommendations was developed during the work. After the start of a simula-

tion with first numerical setup it necessary to check convergence of continuity and momentum equations. In case residuals of the order of at least 10^{-2} for continuity and 10^{-4} for momentum equations are not reached, it is recommended to reduce the Safety factor in Alya input files. Changing the CFL is easier by setting apparently too big Safety factors in for e.g. Temper and Chemic files and controlling a Safety factor in Nastin. The recommended time step for the explicit simulation needs to be below $\delta x/u$, that is below 0.00002s. If the simulation does not converge well, the time step can be reduced.

It is advised to run trial simulations in order to adjust the velocity and get the proper value of the burnt gases density for the initial conditions file.

The simulation has to run to reach at least 10 to 30ms of physical time in order to make sure that a steady state is achieved.

3. Numerical simulation of swirling combustor

The combustion model used for the calculation utilizes a mixture fraction / progress variable approach [5] based on laminar premixed flamelets. The turbulence effects on chemistry is taken into account using a presumed-shape Probability Density Function (PDF). It will be explained further that it is not desirable to include this option in case of RANS simulation.

The results of LDV measurements of velocity are not available for the equivalence ratio considered in the work. That is why the Alya results will be compared with experimental data only in terms of temperature. Velocity and temperature profiles are compared also with the numerical LES results obtained by the code AVBP from CERFACS.

3.1. Physical description

The study case reproduces the experiment carried out by DLR. The combustor geometry is represented in Figure 7. It consists of inlet, plenum, swirler, combustion chamber and outlet. In the experimental setup, the fuel/air mixing occurs in the swirler. The systems creates a swirled flow, which stabilizes the flame. The flame is located in the combustion chamber.

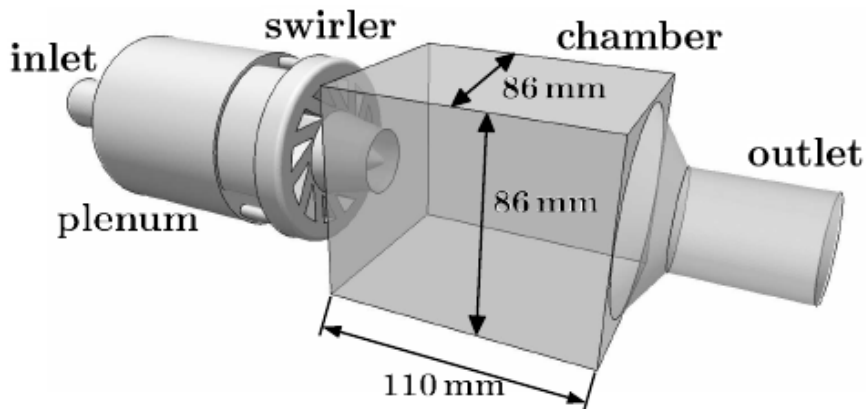

Figure 7: Geometry of the combustor

For the particular case of this project, a perfect mixing between fuel and air is assumed. Therefore, the premixed approach can be utilized, which means that air-fuel mixing is not simulated and homogeneous mixture is injected in the burner. The equivalence ratio $\phi = 0.83$ with a mass

flow rate of 770 g/min corresponding to the stable regime from the experiments. The combustor is assumed to operate at atmospheric pressure and temperature of 320 K.

3.2. Numerical setup

In this study, two modeling approaches are deployed. Firstly, a Reynolds-averaged Navier-Stokes equations with Shear Stress Transport Turbulence Model are considered and secondly, high-fidelity large-eddy simulation (LES) based on the Wall-Adapting Local Eddy-viscosity sub-grid model is utilized.

Both for RANS and LES, wall resolved numerical simulations will be conducted. Both adiabatic and non-adiabatic wall conditions are considered and the comparison will be presented. As the turbulent combustion model [5] employed here can be used in the context of RANS and LES, both approaches will be assessed in this study. It is expected that large improvements will come from the use of LES over RANS, but RANS will be used as an overall indicator of the model predictions and also as initial solutions for LES.

The numerical strategy involves initial conditions evolution. First of all, a non-reacting, so-called cold flow, simulation is carried out so that velocity, key and omega turbulence fields are obtained. Then these fields are checked and used as an initial condition for the reacting, so-called hot flow, simulation. Then the most converged output is converted to initial fields and used to setup the following simulations. Such strategy helps to significantly reduce CPU hours needed to obtain the converged solution.

3.2.1. Mesh description

All structural elements of the combustor were meshed and three different grids were created for the study. In addition to the combustor geometry the exhaust domain was added in order to reduce perturbations. The meshing process is done in ANSYS ICEM environment. TGrid Advancing Front Delaunay algorithm was used for automatic mesh generation. This algorithm utilizes skewness-based refinement and ensures smooth and gradual transition near the surface and more rapid transition in the interior. Afterwards a number of mesh checks for errors (such as duplicate, hanging and penetrating elements), possible problems (such as non-manifold vertices, unconnected vertices and overlapping elements) and smoothings were done.

The generated unstructured mesh consists of triangular surface elements, tetrahedral, prism and pyramid volume elements. 5 prism layers to resolve the boundary layer are created. The layers are adjacent to the cone, which is located between the swirler and the combustion chamber and where the separation point is located. The separation is an important issue to be well resolved as it forms recirculation zones, which strongly influence the flame shape. Such parameters of the mesh as skewness, minimal angle, determinant, aspect ratio and total quality parameter in ICEM is ensured to be acceptable. The parameters of three grids are represented in Table 6. The grids cross sections are shown in Figure 8.

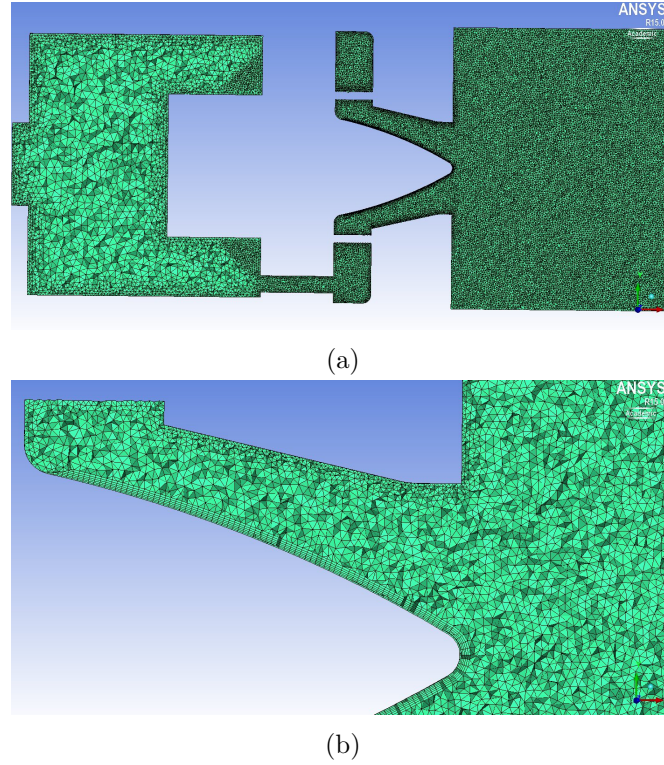

Figure 8: Volume mesh of the combustor: (a) Combustion chamber and upstream; (b) Region of flow entrance to the combustion chamber.

Mesh	Number of elements	Element size in swirler, separation and flame zones
Mesh 1	8.9 million	0.001 m
Mesh 2	13.07 million	0.00086 m
Mesh 3	20.58 million	0.0007 m

Table 6: Major parameters of the investigated meshes

The calculations have converged for all of the created meshes.

3.3. Results of RANS simulations

In case of the adiabatic case, the heat transfer between between combustor and the chamber walls is not taken into account. In the adiabatic framework, the mesh refinement study was carried out. The comparison of temperature profiles of 3 grids with experimental and numerical results obtained using AVBP are shown in Figure 9 and velocity profiles are represented in Annex 1.

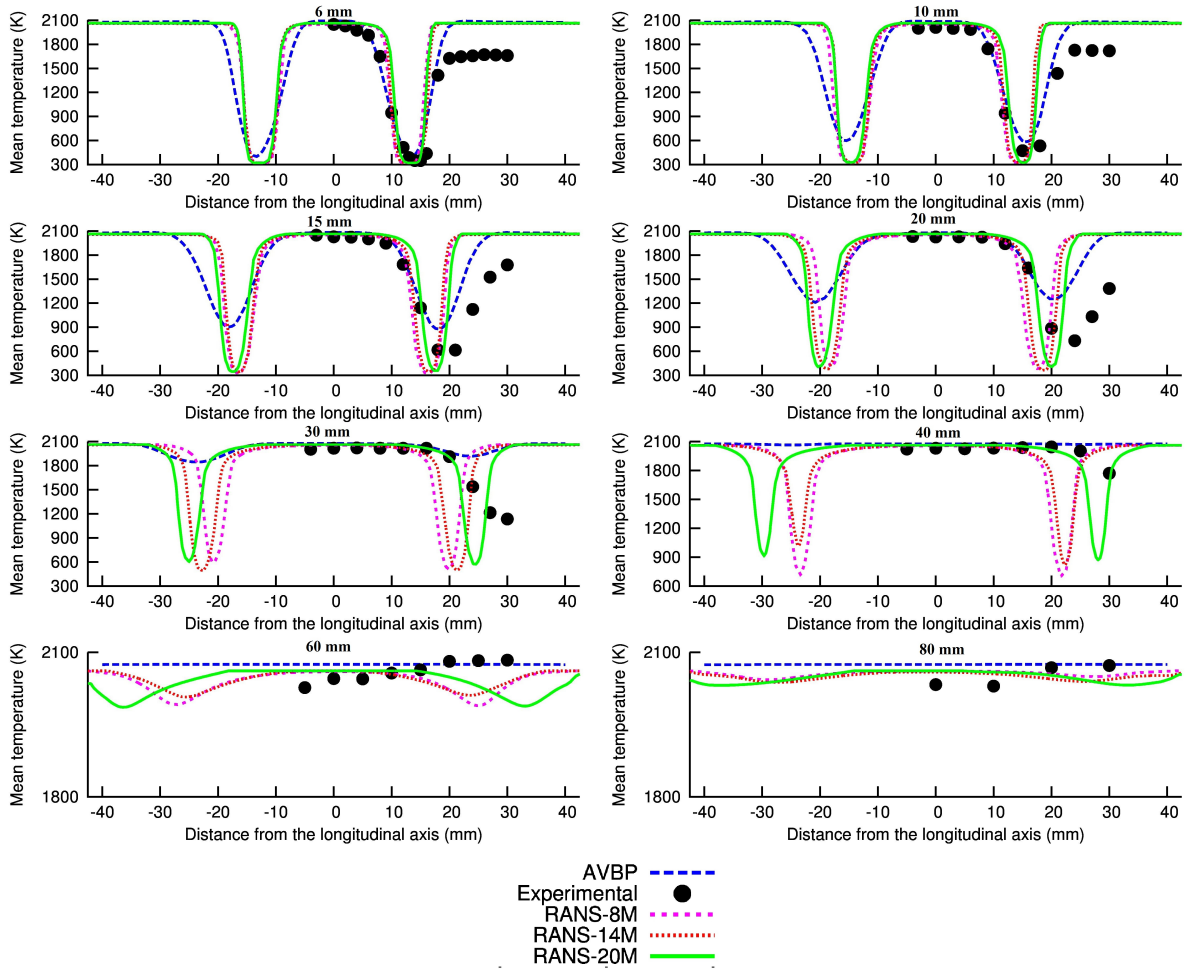

Figure 9: Temperature profiles for three different meshes of 8, 14 and 20 million compared to experimental and numerical reference results

It is observed that after refinement of the mesh the result converges towards the reference ones. In particular, the refinement increases the accuracy of the resulting profiles of scalar values in radial direction. The velocity results of the finest mesh matches well the reference result from CERFACS. However it is observed that for RANS simulations the flame shape is not well reproduced even with the finest mesh and therefore the accuracy of the temperature profiles in the middle cross sections is not acceptable. Note that effect of turbulence on the chemical reactions is not considered in this simulation as turbulence parameters obtained by RANS are not accurate enough.

Based on the mesh study results of adiabatic RANS simulation the grid of 20 million elements was chosen for the following numerical simulations. This will serve as the starting point of the LES.

3.4. Results of Large Eddy Simulations

In the LES framework, while the large scales of the flow are resolved, the small scales are modeled, unlike the RANS method, which utilizes modelling for the entire spectrum of the flow scales. The LES implementation in Alya involves explicit filtering by means of Wall-Adapting Local Eddy-viscosity (WALE) subgrid model, which handles well complex geometries, structured and unstructured meshes. In addition, it takes into account both strain and rotation rate of small turbulent structures [6]. Therefore LES method was expected to perform well for the

PRECCINSTA test case, which is characterized by an unsteady swirling flow.

The adiabatic LES simulation was carried out and comparison with previously obtained RANS results was done, see Figure 10. The temperature fields have substantially improved compared to both numerical and experimental results. The temperature in the flame region is not longer significantly underpredicted as it was in the case of RANS, while the velocity fields are in good agreement with the ones obtained previously in RANS and AVBP.

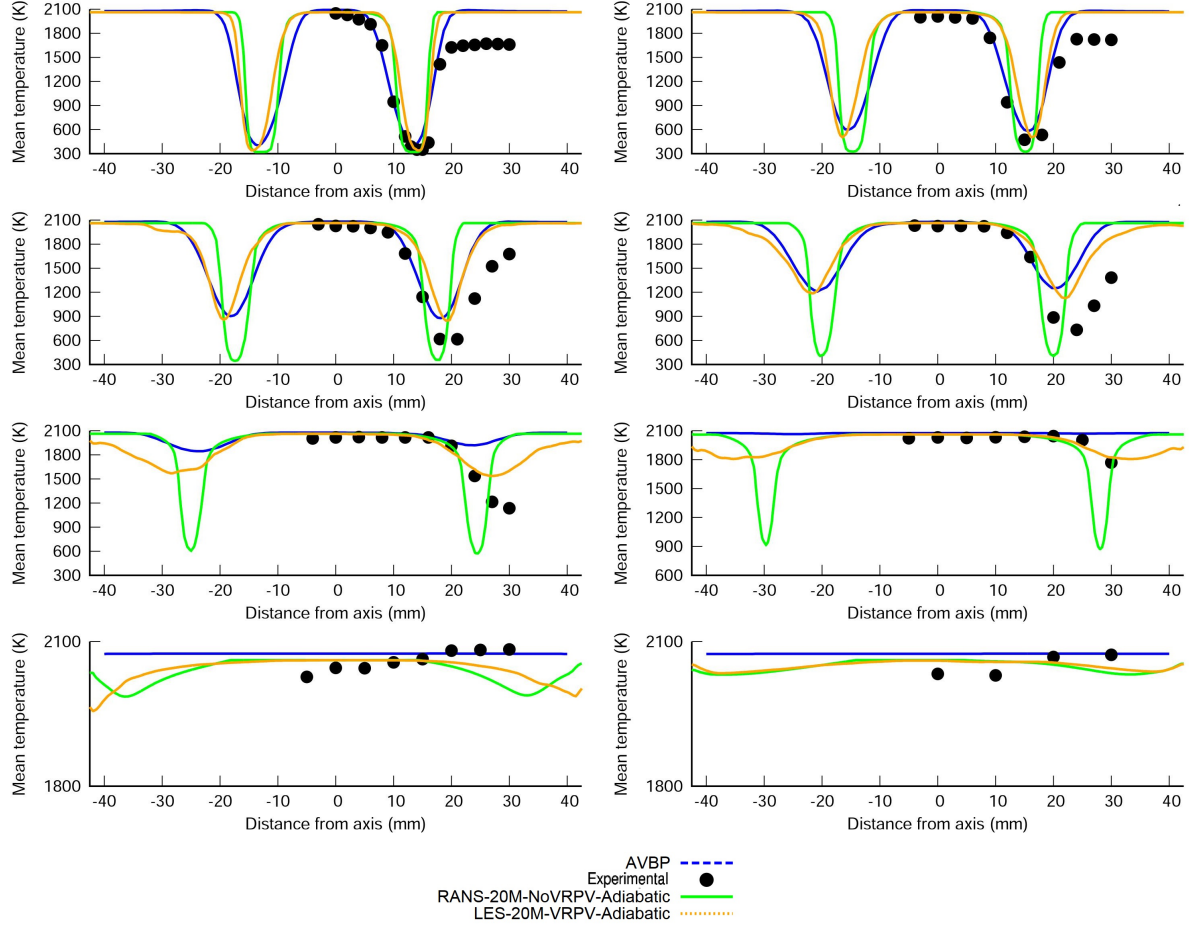

Figure 10: Temperature profiles for LES results compared to RANS simulation, experimental and numerical reference results

Root mean square (RMS) values of temperature fluctuations are shown in Annex 2. The RMS results tend to agree well with experimental data and represent fairly well the position of the peaks. Using AVBP as a reference, Alya does not underpredict RMS values in 30 and 40 mm cross sections, correctly representing turbulent flow characteristics in this part of flame region.

3.5. Conclusions and recommendations

The results obtained in the framework of adiabatic simulations reveal that the temperatures of both Alya and AVBP numerical simulations do not match the experimental in the near-wall region. The possible improvement of the result in this region may be obtained by inclusion of heat losses, which results in local reduction of temperature.

Based on the comparison of LES and RANS numerical results, the following recommendations were developed:

- Turbulence-chemistry interaction should be included in LES but not in RANS as it leads to a very dissipative flow field where the source terms are unphysically reduced;
- RANS even with very fine meshes (20 million) are not able to reproduce the experimental distribution of chemical and thermal values. Though it may be used to predict correctly velocity profiles.

Problems and shortcoming in codes, which have been found during the work:

- In case of 1D flame the initial chemical tabulation, which have been used for simulation, was found to have not optimal distribution, which had resulted in high computational time and wrongly resolved flame zone;
- The obtained result is asymmetric. That can be explained by the fact that the mesh created automatically in ICEM is nonsymmetric;
- Postprocess of Y^+ parameter, which is needed to evaluate mesh quality in the near-wall regions, does not work properly.

Learning goals accomplished during the internship:

- High Performance Computing principles, features of chemical and thermal calculations, Unix shell scripting were studied;
- A number of documentation and publications in Computational Combustion and CFD including such topics as Large Eddy Simulation (LES), mesh generations and tabulation were studied;
- The skills in software as ANSYS ICEM, HPC multiphysics code Alya, ParaView and LaTeX were improved.

The future plans involve continuation of investigations in the field of Computational Combustion in the context of Master's thesis.

References

- [1] R.E.H. Sims, R.N. Schock et al. 2007: Energy supply. In *Climate Change 2007: Mitigation. Contribution of Working Group III to the Fourth Assessment Report of the Intergovernmental Panel on Climate Change* [B. Metz, O.R. Davidson, P.R. Bosch, R. Dave, L.A. Meyer (eds)], Cambridge University Press, Cambridge, United Kingdom and New York, USA.
- [2] J. Galpin, A. Naudin, L. Vervisch, C. Angelberger, O. Colin, P. Domingo Large-eddy simulation of a fuel-lean premixed turbulent swirl-burner, *Combustion and Flame* 155: 247-266, October 2008
- [3] T. J. Poinso, D.P. Veynante, *Theoretical and Numerical Combustion*, 2nd ed., Edwards, 2015.
- [4] H. J. Curran Detailed Chemical Kinetic Modeling; Is There Life after GRI-MECH 3.0?, *ASC Division of Fuel Chemistry Proceedings*, 2004, 49 (1), 263
- [5] S. Gövert, D. Mira, J.B.W. Kok, M. Vázquez, G. Houzeaux, Turbulent combustion modelling of a coned premixed methane/air jet using tabulated chemistry, *Applied Energy*, Volume 66, 2015, pp. 313-316.
- [6] F. Nicoud, F. Ducros Subgrid-scale stress modelling based on the square of the velocity gradient tensor, *Flow, Turbulence and Combustion*, April 1999, p. 7.

ANNEX

Annex 1

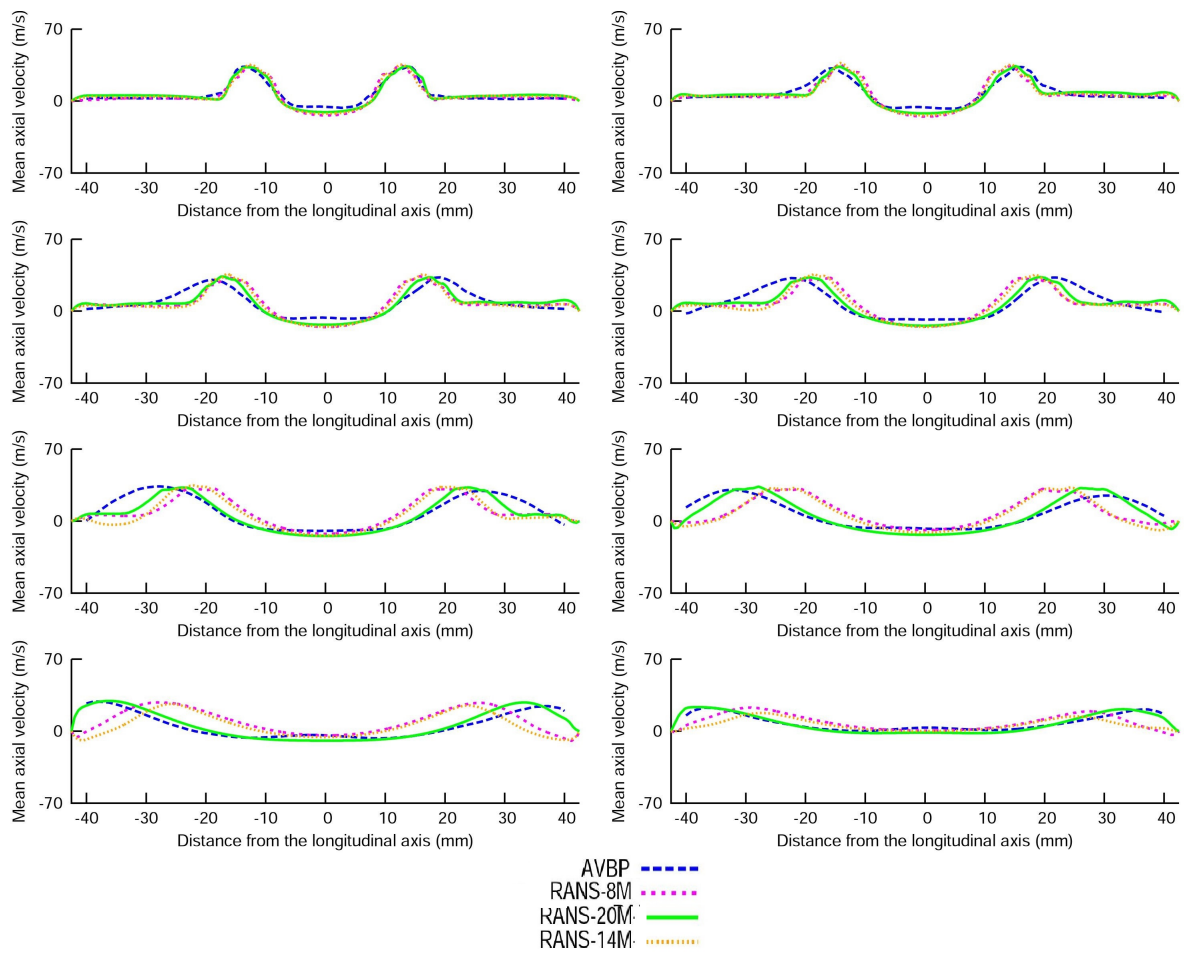

Figure 11: Axial velocity profiles for three different meshes of 8, 14 and 20 million compared to experimental and numerical reference results

Annex 2

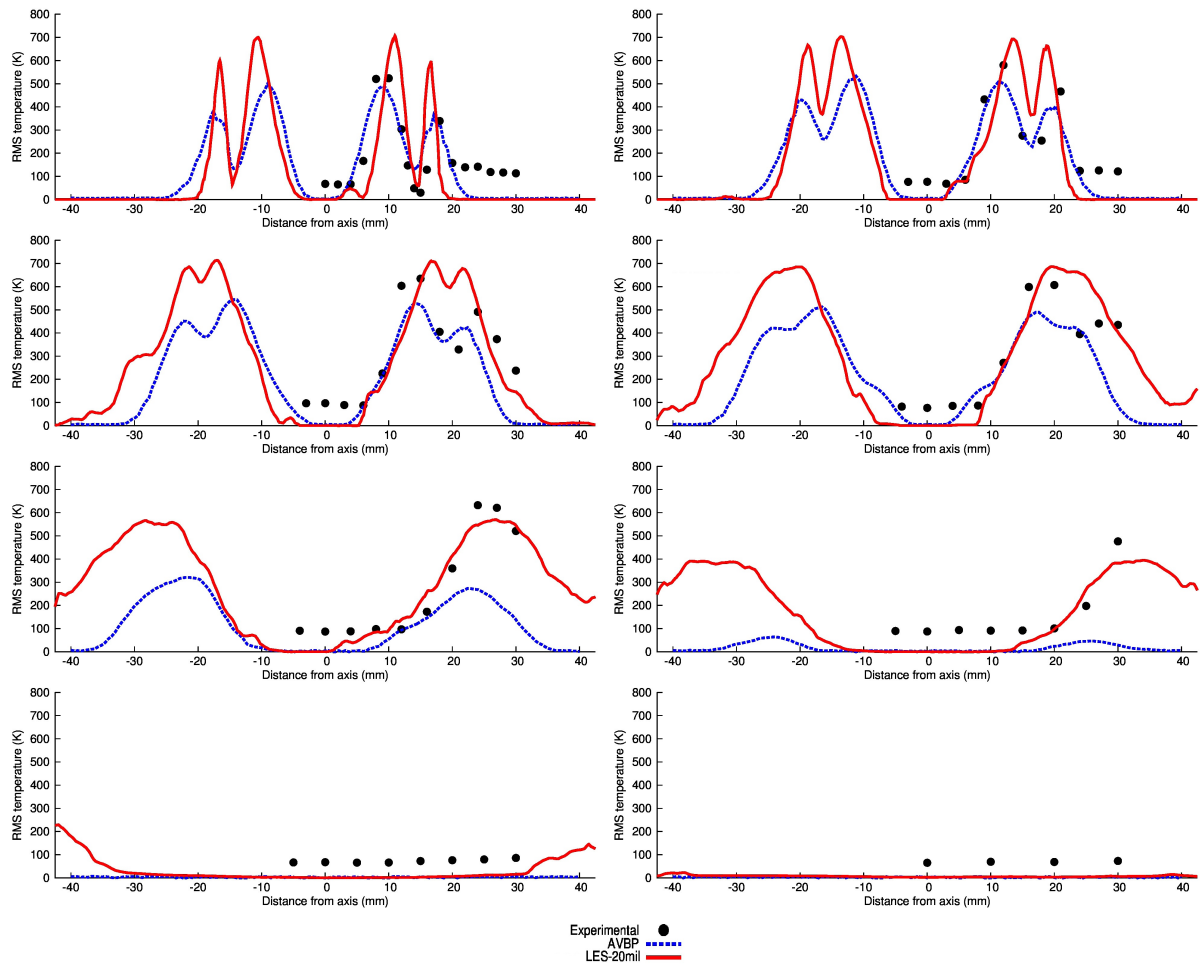

Figure 12: RMS values of temperature fluctuations for LES simulation compared to experimental and numerical reference results